

User's Manual

SERVO-s VENTILATOR SYSTEM V7.0

MAQUET
GETINGE GROUP



TABLE OF CONTENTS

1	Introduction		5
2	System Overview		15
3	Power supply		35
4	Operation overview		41
5	Monitor and record		59
6	Ventilation, modes and functions		67
7	Alarms		119
8	Optional Accessories		127
9	System messages		131
10	Start-up configuration		139
11	Technical data		143
12	Definitions		163
13	Appendix • User interface		165
14	Certificates		177
15	Index		179

1 INTRODUCTION

TABLE OF CONTENTS

1.1	Device description		6
1.2	Warning, Caution, Important and Note		8
1.3	Version and Configurations		13

1.1 DEVICE DESCRIPTION

This section provides general information about the SERVO-s Ventilator System along with guidelines for appropriate use.

1.1.1 DEVICE DIAGRAM

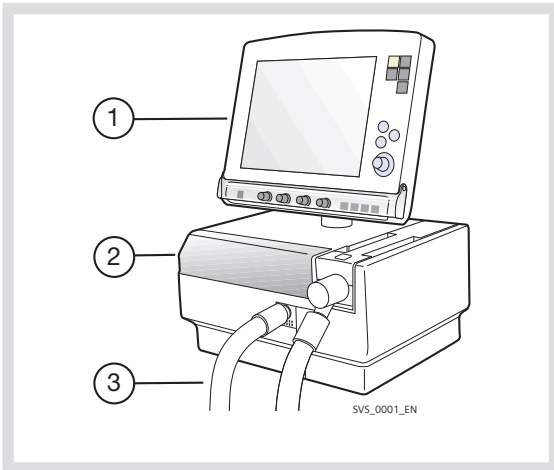

1.1.2 DEVICE COMPONENTS

The SERVO-s Ventilator System consists of the following components:

1. User Interface—for setting ventilation modes, displaying patient data, and indicating alarms
2. Patient Unit—for mixing gases
3. Patient Breathing System—for delivering and exchanging gases

1.1.3 INTENDED USE

The SERVO-s Ventilator System is intended for treating and monitoring patients ranging from pediatrics to adults with respiratory failure or respiratory insufficiency

1.1.4 INTENDED USER

The SERVO-s Ventilator System should be used only by those who:

- are professional healthcare providers, and
- have received training in the use of this system, and
- have experience of ventilation treatment.

1.1.5 INTENDED USE ENVIRONMENT

The SERVO-s Ventilator System should be used only:

- in hospitals
- in facilities whose primary purpose is to provide healthcare
- during transport of a patient within hospitals or healthcare facilities

1.1.6 CLEANING AND MAINTENANCE

Please refer to the SERVO-i/s Cleaning and Maintenance User's Manual.

1.1.7 SERVICING GUIDELINES

CAUTIONS:

- **Regular Service:** The SERVO-s Ventilator System must be serviced at regular intervals by MAQUET authorized personnel who have received specialized training.
- **Complete Service Records:** All service performed on the SERVO-s Ventilator System must be recorded in a service log in accordance with hospital procedures and local and national regulations.
- **Service Contract:** We strongly recommend that all service on the SERVO-s Ventilator System should be performed as part of a service contract with MAQUET.

1.1.8 DISCLAIMERS

- **Improper Use Environment**
MAQUET has no responsibility for the safe operation of SERVO-s Ventilator System if the *Intended Use Environment* requirements specified in this document are not followed.
- **Nonprofessional Servicing**
MAQUET has no responsibility for the safe operation of the SERVO-s Ventilator System if installation, service or repairs are performed by persons other than MAQUET authorized personnel.

1.2 WARNING, CAUTION, IMPORTANT AND NOTE

Follow these safety guidelines. Additional warnings appear in context throughout this document.

Information is highlighted with Warning, Caution, Important or Note, where:

WARNING! Indicates critical information about a potential serious outcome to the patient or the user.

CAUTION: Indicates instructions that must be followed in order to ensure the proper operation of the equipment.

Important: Indicates information intended to help you operate the equipment or its connected devices easily and conveniently.

Note: Indicates information requiring special attention.

1.2.1 GENERAL

This manual summarizes the functions and safety features of the SERVO-s Ventilator System. It is not all-inclusive and should not be construed as a substitute for training.

WARNING!

- Always perform a Pre-use check before connecting the ventilator to a patient.
- If any of the following occurs, discontinue use of the ventilator and contact a service technician:
 - Unfamiliar pop-up windows on the screen
 - Unresolvable alarms
 - Unfamiliar sounds
 - Any unfamiliar or unexplained event
- Keep the ventilator upright during use.
- Make sure that ventilation is started when a patient is connected to the ventilator. When the ventilator is in Standby, a flashing message, *Patient not ventilated*, is displayed as a reminder directly above the word Standby.
- When the ventilator is connected to a patient:
 - Do not lift or disconnect the expiratory cassette.
 - Continuously monitor the settings and measurements displayed on the screen.
 - Make sure a resuscitator is readily available.
- The SERVO-s Ventilator System must be operated only by authorized personnel who are well trained in its use. It must be operated according to the instructions in this User's manual.

- Do not modify or remove any original parts.
- Do not cover the ventilator in any way, since the functioning of the equipment may be adversely affected.
- When the ventilator is used for MCare Remote Service, use only network equipment that is safe and in compliance with the relevant electrical and EMC standards such as IEC-60950.

Note: The network cable is excluded from this requirement.

- Always disconnect the network cable before starting ventilation when the ventilator is used for MCare Remote Service.
- Positive pressure ventilation can be associated with the following adverse events: barotrauma, hypoventilation, hyperventilation or circulatory impairment.
- The SERVO-s Ventilator System is not intended to be used during radiotherapy, since this may cause system malfunction.
- The SERVO-s Ventilator System must not be used in a hyperbaric chamber.
- The SERVO-s Ventilator System must not be used with helium.
- Only accessories, supplies, and auxiliary equipment recommended by MAQUET should be used with the ventilator system. Use of any other accessories, spare parts or auxiliary equipment may cause degraded system performance and safety.
- The power supply cord must be plugged directly into the mains power outlet without the use of any multiple socket

outlets. If a multiple socket outlet is used together with other products, total leakage current might be exceeded at earth fault.

CAUTIONS:

- In USA, Federal law restricts this device to sale by or on the order of a physician.
- The expiratory channel and expired gas from the exhaust port may be contaminated.
- Refer to the Installation instructions to assemble the system or options to obtain a proper mechanical assembly.
- Service, repair and installation must be performed by MAQUET authorized personnel only.
- When lifting or moving the ventilator system or parts of the system, follow established ergonomic guidelines, ask for assistance, and take appropriate safety precautions.
- Before use, make sure the system version displayed under *Status* corresponds to the system version described in the User's Manual.
- Extra care should be taken when handling tubes, connectors and other parts of the patient circuit. The use of a support arm to relieve the patient from the weight of the tubing system is recommended.
- When using the MCare Remote Service function, install the network cable so that there is no risk of anyone tripping over it.
- Do not leave the patient unattended when connected to the ventilator.
- MAQUET has no responsibility for the safe operation of SERVO-s Ventilator System if the *Intended Use* requirements specified in this document are not followed.

- Contact a MAQUET representative regarding decommissioning of the equipment.
- Disconnect the mains power cable from the outlet to isolate the ventilator from mains power.
- Do not touch accessible connector contacts and the patient simultaneously.

Important:

- Always use a heat and moisture exchanger (HME) or equipment to prevent dehydration of lung tissue.
- Securely attach all cables, etc, to minimize the risk of unintentional disconnection.
- All excess fluids must be disposed according to hospital routines.

1.2.2 POWER SUPPLY

WARNINGS!

- The power cord must be connected only to a properly grounded AC electrical outlet to avoid the risk of electrical shock.
- If only built-in batteries are mounted inside the patient unit, then a high priority alarm is activated if one or more of these batteries are missing.

CAUTIONS:

- Do NOT use antistatic or electrically conductive tubing with this system.
- Avoid contact with external electrical connector pins.

1.2.3 FIRE HAZARD

WARNINGS!

- Keep the system and its gas hoses clear of all ignition sources.
- Do not use the system with worn or frayed hoses or hoses that have been contaminated by combustible materials such as grease or oil.
- Oxygen-enriched gas is extremely flammable: if you detect a burning odor, disconnect the oxygen supply, mains power and remove the batteries.
- Make sure that both the mains power outlet and the power supply connector are accessible.

1.2.4 GASES

CAUTION: The system is not intended to be used with any anesthetic agent.

Important:

- Supplied gases shall meet the requirements for medical grade gases according to applicable standards.

Maximum levels:

Air

- $H_2O < 7 \text{ g/m}^3$
- Oil $< 0.5 \text{ mg/m}^3$
- Chlorine: must not be detectable ¹

Oxygen

- $H_2O < 20 \text{ mg/m}^3$
- Oil $< 0.3 \text{ mg/m}^3$

Note: For devices with serial numbers below 25000 that are updated to version 7.0, the maximum inlet gas pressure will be reduced (see the Technical data chapter on page 146).

1.2.5 AUXILIARY EQUIPMENT

CAUTIONS:

- Accessories, supplies, and auxiliary equipment used with the ventilator should:
 - be recommended by MAQUET
 - meet EN/IEC 60601-1 standards
 - meet IEC standards as a whole system
- If a scavenging system (i.e. gas evacuation) is connected to the ventilator, it must conform to ISO8835-3 guidelines for subatmospheric pressure and induced flow.
- Measurements of parameter values that have been processed by auxiliary equipment:
 - may be inaccurate if equipment not authorized by MAQUET is used
 - should be discounted if they conflict with information on the ventilator screen
 - must not substitute for therapeutic or diagnostic decisions

Note: Applied parts, i.e. equipment making physical contact with the patient, comprise nebulizer patient unit and cable and the Ventilator Breathing System described in System Flow Chart, Ventilation, Patient Connection, part no. 66 92 522.

1. If the compressed air is generated by a liquid ring compressor there is a potential risk of chlorine in the supplied air.

1.3 VERSION AND CONFIGURATIONS

This manual applies to version 7.0 of the SERVO-s Ventilator System.

1.3.1 PATIENT RANGE (KG)

Weight 10 – 250 kg.

1.3.2 CONFIGURATIONS

The SERVO-s Ventilator System can be used in both invasive and non invasive ventilation.



Standard Configuration



Options

Bi-Vent



Non Invasive Ventilation (NIV)



Lung Mechanics



PRVC (incl. SIMV (PRVC) + PS)



PC (incl. SIMV (PC) + PS)



VC (incl. SIMV (VC) + PS)



PS/CPAP



2 SYSTEM OVERVIEW

TABLE OF CONTENTS

2.1	Ventilator		16
2.2	User Interface - Connections, labels and symbols		18
2.3	Navigating the User Interface		21
2.4	Patient Unit - Connections, labels and symbols		28
2.5	Transport and storage		34

2.1 VENTILATOR

The User Interface is used to control ventilator settings. Settings may be adjusted using touchpads on the screen or a rotary dial.

Breathing parameters are continuously measured and controlled. A difference between the actual measured value of a parameter and the preset or calculated value results in the adjustment of gas delivery to achieve the target value.

The system has two gas modules, one for air and one for O₂. Gases may be supplied by a medical pipeline system, a compressor, or by gas tanks.

Ensure that the ventilator is in its locked position on the cart or holder used, to prevent unintentional movements.

CAUTION: Lock the wheels if the ventilator is not to be used for transportation.

2.1.1 SYSTEM OVERVIEW DIAGRAM

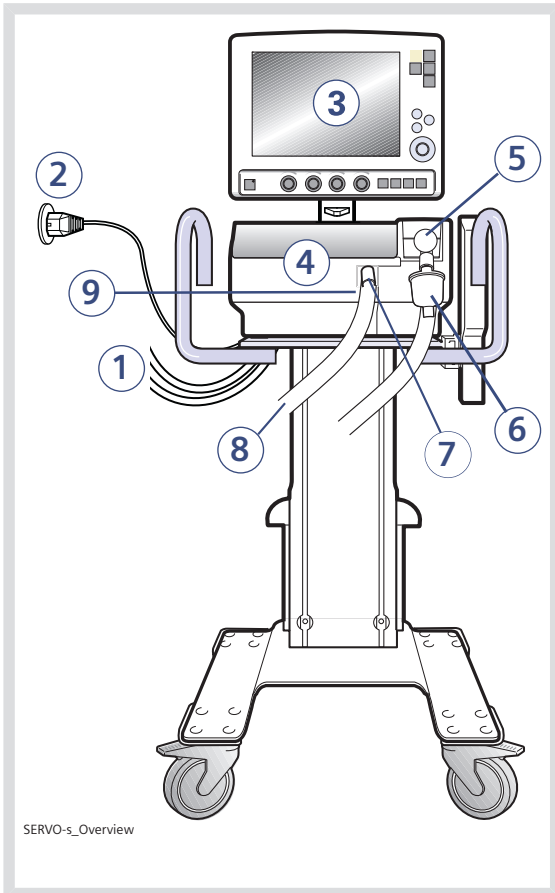

2.1.2 SYSTEM COMPONENTS

1. Air and O₂ supply
2. Power cable
3. User Interface
4. Patient Unit
5. Expiratory inlet
6. Servo Duo Guard, viral/bacterial filter
7. Inspiratory outlet
8. Patient circuit
9. Emergency air intake

2.2 USER INTERFACE - CONNECTIONS, LABELS AND SYMBOLS

The User Interface includes:

- a screen with active touchpads
- fixed keys
- a rotary dial

2.2.1 USER INTERFACE DIAGRAM

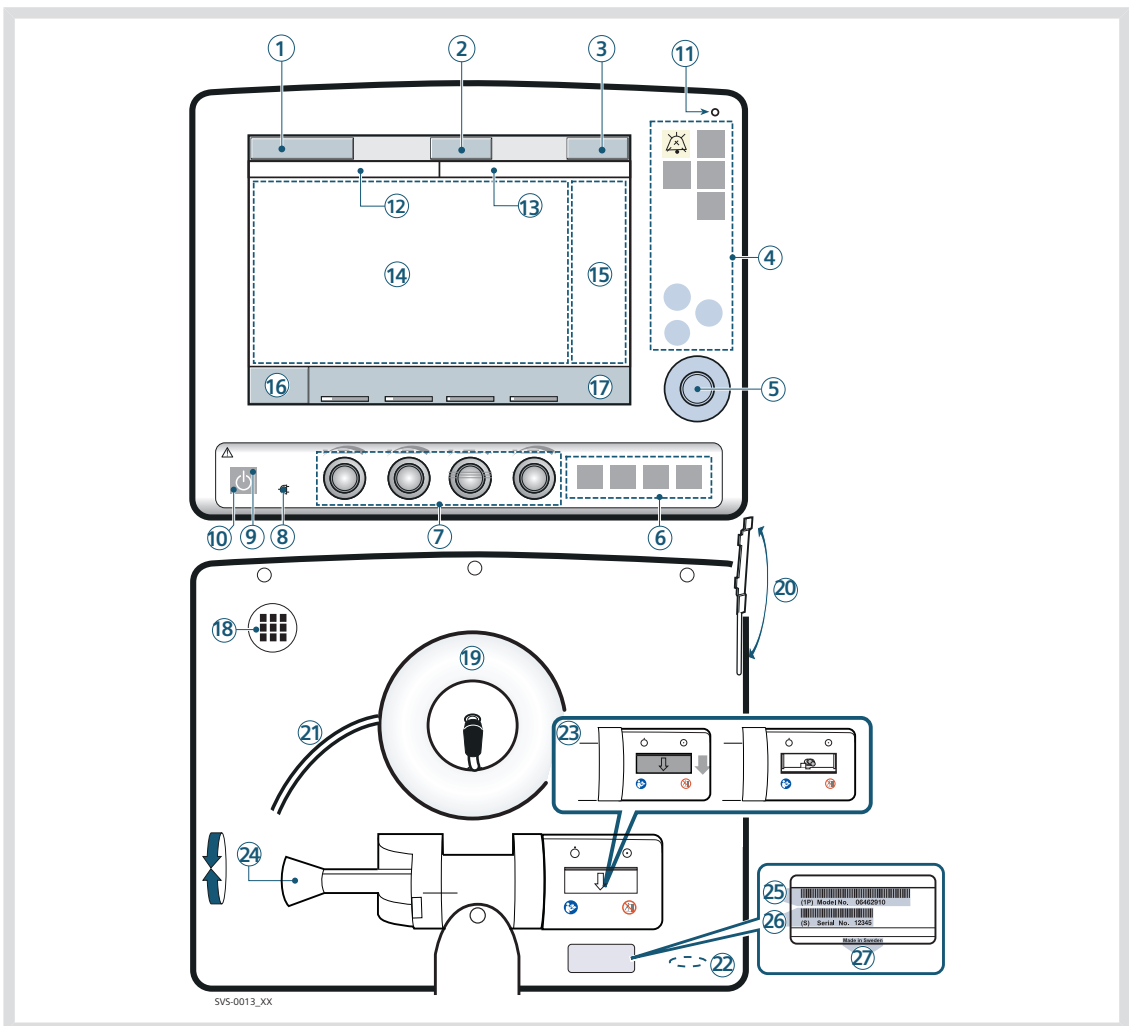













2.2.2 USER INTERFACE COMPONENTS

Refer to the User Interface Diagram for the location of the following numbered components:

1. Current mode of ventilation
2. Admit patient/Entered patient data and admission date
3. System status parameters
4. Fixed keys
5. Main Rotary Dial—used to select a menu touchpad or parameter box, to adjust values, and to confirm settings
6. Special Function Keys—used to start special ventilatory functions
7. Direct Access Knobs—used for immediate adjustment of breathing parameters
8. AC Power indicator (green)
9. Standby indicator (yellow)—when the ventilator is in Standby, a flashing message, *Patient not ventilated*, is displayed on the screen directly above the word Standby.
10. Start/Standby key
11. Luminescence detector—for automatically adjusting screen brightness
12. Text messages, including patient triggering symbols
13. Alarm messages
14. Waveform area—for monitoring two to three individually scaled parameters, including a volume/pressure loop and a flow/volume loop
15. Measured values and alarm limits display (customizable)
16. Additional settings
17. Additional measured values
18. Loudspeaker
19. Cable reel for the control cable
20. Slot for PC card with a cover
21. Control cable
22. Service connector
23. On/off switch
24. Locking lever for tilting
25. Model number
26. Serial number
27. Manufacturing information

2.2.3 USER INTERFACE SYMBOLS

Symbol	Description
	Audio Pause - silence or confirm an alarm. Note: This symbol may be different depending on User interface version.
	Audio off
	Audio Pause - all alarms, active and inactive, are pre-silenced.
	Attention—consult documentation Note: This symbol may be different depending on User Interface version
	Do not push the User Interface as the ventilator may tip over.
	Start ventilation/Standby—yellow indicates Standby
	Power indicator—green indicates AC power connected
	Battery—indicates ventilator is using battery power, with estimated minutes remaining
12 V	12 V - indicates that external 12V DC is connected.
	ON/OFF switch
	Trigger indication—appears in the message/alarm field when the patient triggers a breath
	Volume Control with flow adaptation
	Volume Control without flow adaptation
	Volume Control with decelerating flow
Note: The patient unit symbols are described later in this chapter.	

2.3 NAVIGATING THE USER INTERFACE

The following subsections provide general procedures for working with the user interface. More detailed procedures for specific tasks are found in later chapters and in the *Appendix*.

2.3.1 TOUCH SCREEN

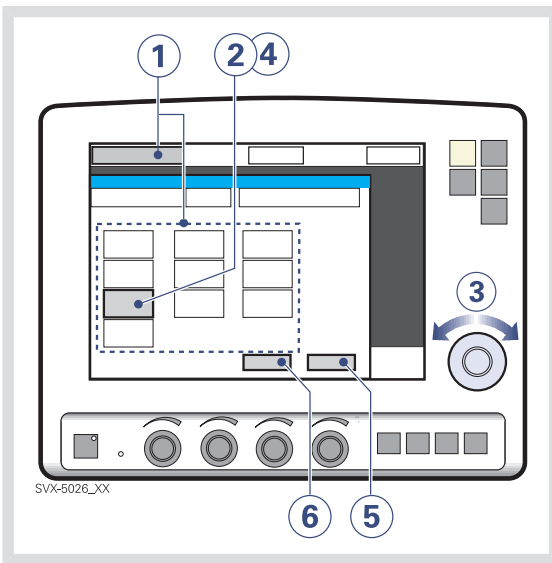

To adjust ventilator settings:

1. Activate the desired menu by touching one of the pads at the top of the screen.
2. Activate the desired parameter by pressing its touchpad. The touchpad is now highlighted in white with a blue frame and it is possible to set a new value.
3. Turn the Main Rotary Dial to the desired value or line.
4. Confirm each setting by pressing the parameter touchpad or pressing the Main Rotary Dial.
5. The touchpad turns grey again indicating that the new setting has been entered.
6. Press *Accept* to activate the new settings, or *Cancel* to start over.

Important: Different ways of interacting with the screen will affect its lifetime. Never use any sharp or pointed objects, such as ballpoint pens, on the screen.

2.3.2 MAIN ROTARY DIAL

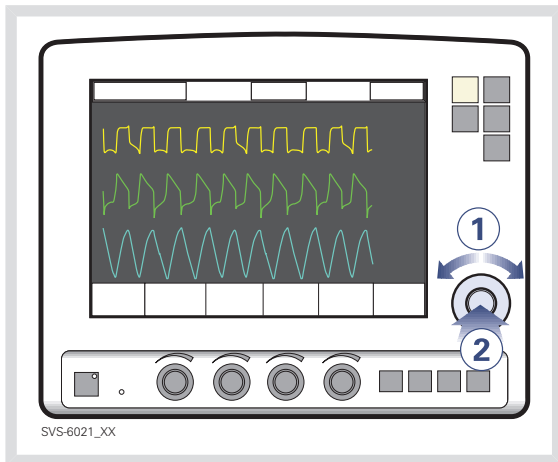

To use an alternative method for adjusting ventilator settings once the desired menu is activated:

1. Turn the Main Rotary Dial until the desired menu touchpad is marked with a blue frame.
2. Press the Main Rotary Dial to confirm. The menu touchpad is highlighted in white with a blue frame, indicating that a new value can be entered.
3. Turn the Main Rotary Dial to the desired value or line.

4. Confirm the setting by pressing the Main Rotary Dial. The parameter touchpad turns grey again indicating that a new setting has been entered.
5. Touch *Accept* to activate your settings, or *Cancel* to start over.

Note: When the defined safety limits for a given parameter have been reached, the Main Rotary Dial becomes inoperative for 2 seconds to indicate that a limit has been reached.

2.3.3 FIXED KEYS

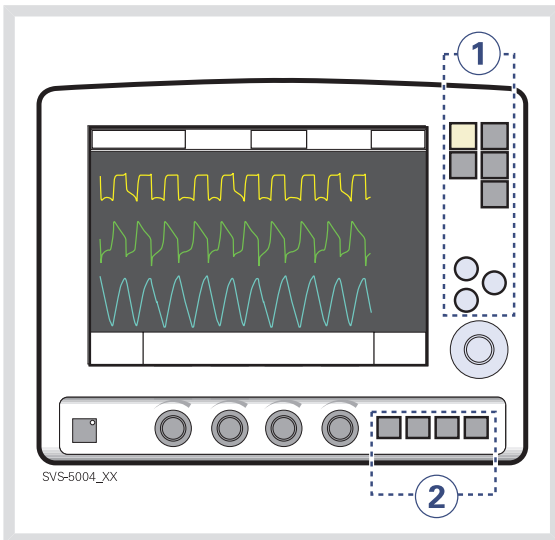

There are two groups of fixed keys on the user interface screen:

1. The keys in group 1 activate user interface functions such as *Save* and access various screens such as *Menu*.
2. The keys in group 2 start special ventilatory functions

Important: The special ventilatory functions require continuous supervision.

2.3.4 DIRECT ACCESS KNOBS

The four dials along the bottom of the User Interface screen are the Direct Access Knobs. They permit direct control of four breathing parameters, which are automatically selected depending on ventilation mode.

Using Direct Access Knobs

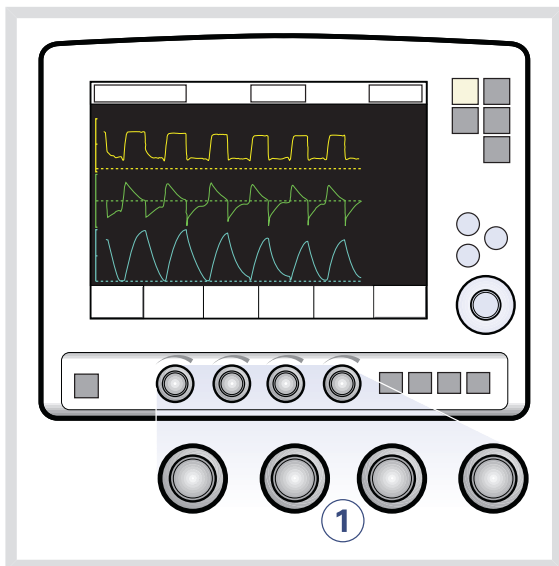

To adjust a breathing parameter directly:

1. Turn the Direct Access Knob corresponding to the parameter you wish to change until the desired value is displayed on the screen.

WARNING! When you adjust a breathing parameter using a Direct Access Knob, the parameter will change immediately starting with the next breath; no additional confirmation is required.

The Main Rotary Dial and Direct Access Knobs become inoperative for 2 seconds when the user reaches a defined safety limit for the parameter being adjusted.

Direct Access Knobs - Safety

The four Direct Access Knob parameters are displayed at the bottom of the screen with color-coded bars that indicate whether the parameter values are within generally-recognized safety limits.

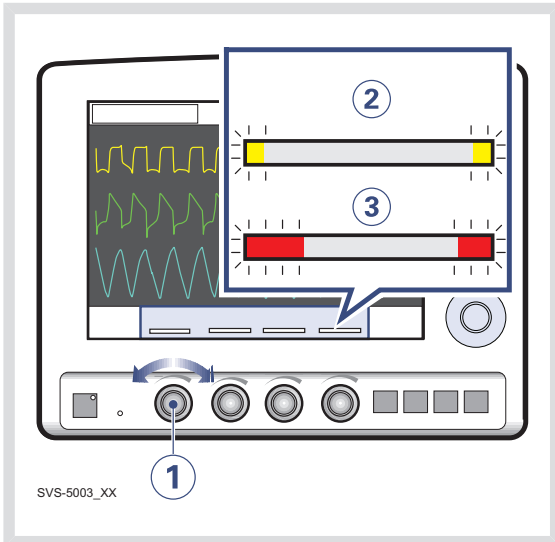

The figure above shows the following components.

1. A Direct Access Knob
2. A yellow bar indicating the corresponding parameter value is outside safety limits; a text message is displayed accompanied by an audible signal.
3. A red bar indicating the corresponding parameter value is *significantly* outside safety limits; a text message is displayed accompanied by an audible signal.

Note: When the defined safety limits for a given parameter have been reached, the Direct Access Knob becomes inoperative for 2 seconds to indicate that a safety limit has been reached.

2.3.5 MENU KEY

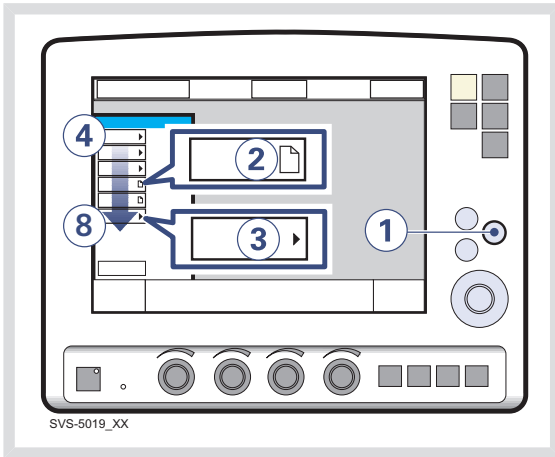

Press any of the following touchpads.

4. *Alarm*
5. *Review*
6. *Compensate*
7. *Biomed*
8. *Panel lock*

For more information see Appendix • User interface on page 165.

To access the user interface windows:

1. Press the fixed key *Menu*.
Touchpads leading to the user interface windows appear.
2. If the touchpad shows a sheet icon, press the touchpad to open a user interface window, OR
3. If the touchpad shows an arrow icon, press the touchpad to display the submenu.

2.3.6 STATUS TOUCHPAD

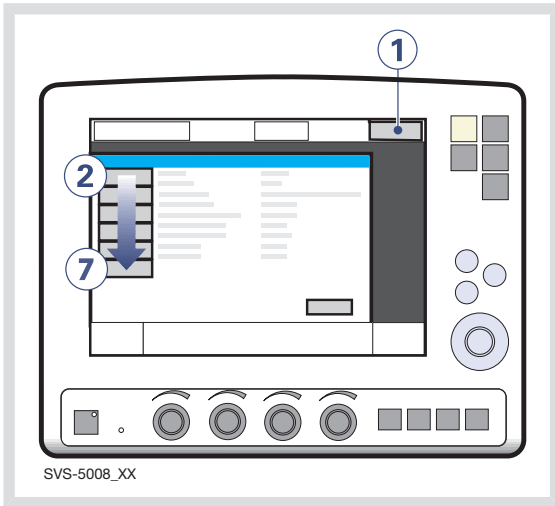

Press any of the following touchpads.

2. *General*
3. *O₂ cell / O₂ Sensor*
4. *Expiratory cassette*
5. *Batteries*
6. *Pre-use check*
7. *Patient Circuit*

The Status touchpad indicates the power supply currently being used by the ventilator (AC power, battery power, or external 12V DC power). If the ventilator is running on battery power, the estimated remaining battery time in minutes is shown.

To access the status window:

1. Press the *Status* touchpad.
Touchpads leading to status windows appear.

2.4 PATIENT UNIT - CONNECTIONS, LABELS AND SYMBOLS

The patient unit consists of the following components:

- gas supplies and their connectors
- power supplies and their connectors
- connectors for accessories

PATIENT UNIT DIAGRAM

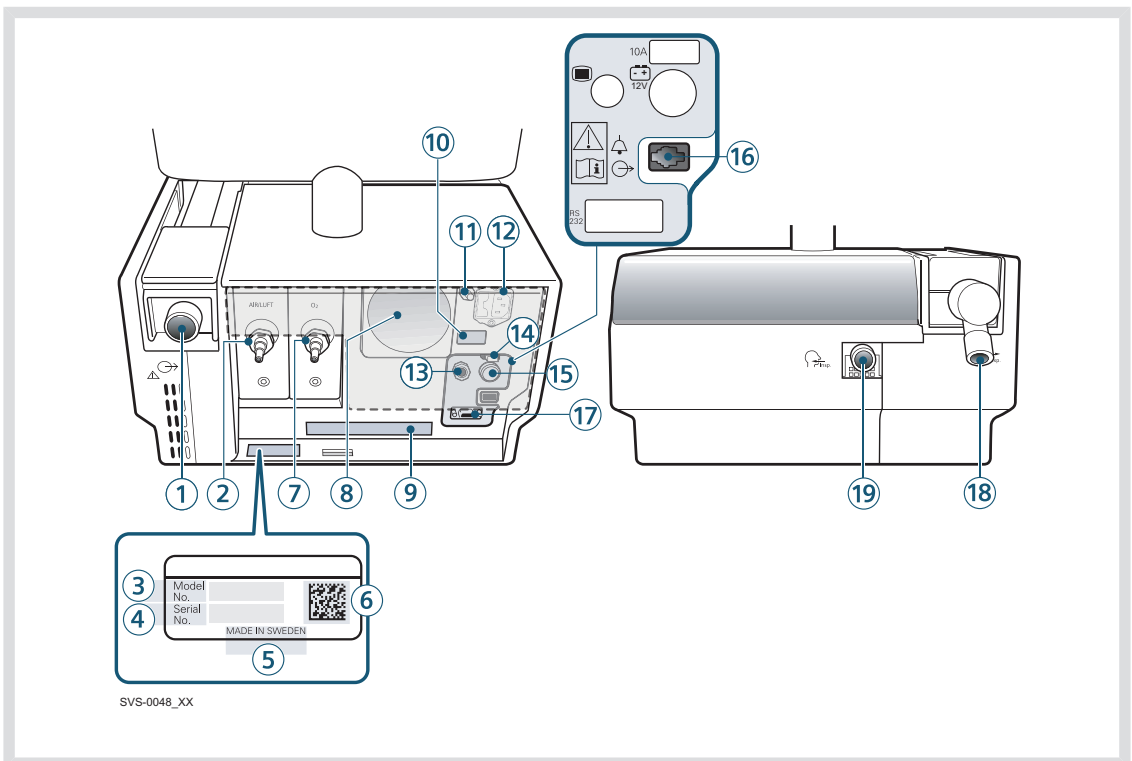









2.4.1 PATIENT UNIT COMPONENTS











CONNECTIONS AND LABELS

Refer to the Patient Unit Diagram for the location of the following numbered components:

1. Expiratory outlet
2. Gas inlet for air
3. Model number
4. Serial number
5. Manufacturing information
6. UDI label
7. Gas inlet for O₂
8. Cooling fan with filter
9. Label
10. Label
11. Equipotentiality terminal
12. AC power supply connector with fuse
13. User interface connector
14. Fuse for external DC power supply
15. External +12V DC inlet
16. Alarm output connection
17. RS-232 connector
18. Inspiratory outlet
19. Expiratory inlet

2.4.2 PATIENT UNIT SYMBOLS

Symbol	Explanation
 0123	CE label—indicates compliance with the requirements of the Medical Device Directive 93/42/EEC
 C US	CSA label—Indicates compliance with Canadian and US standards
 DE 01	PCT label - indicates compliance with Russian standards
	UDI Label - Unique Device Identification. See technical specifications, page 161.
	Class I equipment, Type B—indicates classification according to IEC 60601-1/EN 60601-1
	Equipotentiality terminal Note: The equipotentiality terminal is designed for the connection of a potential equalization conductor according to DIN 42 801 and EN/IEC 60601-1. The function of the equipotentiality terminal is to equalize potentials between the system and other medical electrical devices that can be touched simultaneously. The equipotentiality terminal must not be used for a protective earth connection.
RS 232	RS 232 / Serial port—connector for data communication. Note: This symbol may be different depending on Patient Unit version.
	User Interface connector Note: This symbol may be different depending on Patient Unit version.
10A	10A Fuse for external DC power supply.
 12V	External 12V DC input Note: This symbol may be different depending on Patient Unit version.
	Expiratory label—gas flow from patient.

Symbol	Explanation
	Inspiratory label—gas flow to patient.
	Gas exhaust port label—exhaust gas flow from ventilator Note: This port should not be connected to a spirometer because the volume through the exhaust port is not equal to the expired volume from the patient.
	Alarm output connection option—external alarm output communication
	Special waste. This product contains electronic and electrical components. Discard disposable, replaced and left-over parts in accordance with appropriate industrial and environmental standards.
	Caution
	Consult Instructions for use
	Batteries
	18 kg Weight - Patient unit and User interface.
	Do not expose the battery to heat or fire.
	Do not expose the battery to mechanical force.
	Do not dismantle, open or shred the battery.

PATIENT UNIT GAS FLOW DIAGRAM

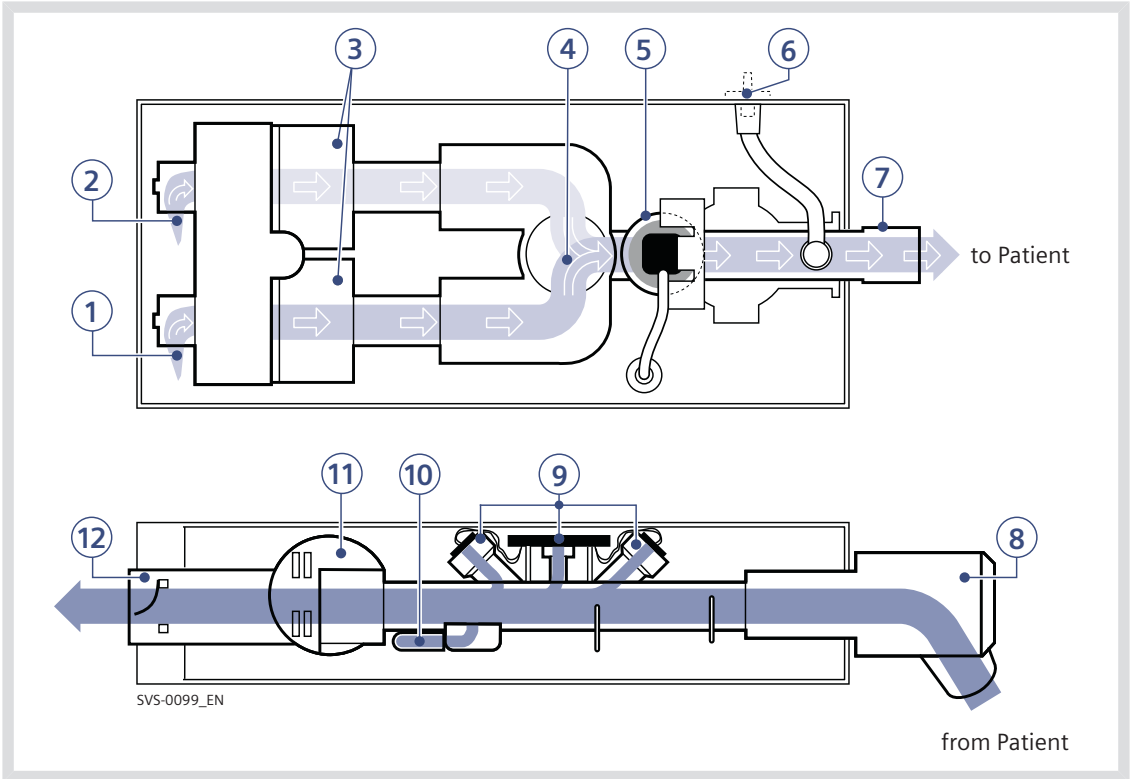

GAS FLOW THROUGH THE PATIENT UNIT

Refer to the Patient Unit gas flow diagram for the location of the following numbered components:

1. Gas inlet for O₂
2. Gas inlet for air
3. The gas flow is regulated by the gas modules for Air and O₂.
4. The gases are mixed in the inspiratory mixing section.
5. The Oxygen concentration can be measured with an O₂ cell or O₂ sensor.
An O₂ cell is shown here.
The O₂ cell is protected by a bacteria filter.
6. The pressure of the mixed gas delivered to the patient is measured by the Inspiratory pressure transducer.
The transducer is protected by a bacterial filter.
7. The inspiratory channel delivers the mixed gas to the patient systems inspiratory tubing. The inspiratory channel also contains a safety valve.
8. The patient breathing systems expiratory tubing is connected to the expiratory inlet. The inlet also contains a moisture trap.

9. The gas flow through the expiratory channel is measured by ultrasonic transducers.
10. The expiratory pressure is measured by the expiratory pressure transducer (located inside the ventilator). The transducer is protected by a bacterial filter inside the expiratory cassette.
11. The pressure (PEEP) in the patient system is regulated by the expiratory valve.
12. Gas from the patient system leaves the ventilator via the expiratory outlet. The outlet contains a non-return valve.

Note: The expiratory cassette can be exchanged between different SERVO-s and SERVO-i Ventilator Systems. Always perform a Pre-use check after exchanging an expiratory cassette.

2.4.3 SYMBOLS ON ACCESSORIES AND PACKAGING

Symbol	Explanation
	Do not re-use. Single use only.
	Recycling. Worn-out batteries must be recycled or disposed of properly in accordance with appropriate industrial and environmental standards.
<small>Hazardous waste (infectious)</small> 	Hazardous waste (infectious) The device contains parts which must not be disposed of with ordinary waste.
	No stepping on surface
	Order number
	Number to identify the production batch
QTY	Quantity
	Use by date
	Do not use if packaging is damaged
	Attention—consult documentation
	Manufacturer
	CE label—indicates compliance with the requirements of the Medical Device Directive 93/42/EEC
0123	Manufacturing date
	Federal law restricts this device to sale by or on the order of a physician.
	Humidity limitation
	Temperature limitation
	Type B—indicates classification according to IEC 60601-1/EN 60601-1
	Fragile - handle with care

Symbol	Explanation
	Keep away from water
	This way up - indicates correct upright position of the transport package
	Atmospheric pressure limitation
	The support arm must be folded during transport.

2.5 TRANSPORT AND STORAGE

2.5.1 BEFORE INTRAHOSPITAL TRANSPORT

Before transporting the ventilator with or without a patient connected, follow facility guidelines and:

- Be sure the patient unit is securely attached and locked to the mobile unit.
- Be sure all accessories such as gas cylinders, and humidifier are securely attached and locked.
- Be sure the gas cylinders are connected and have sufficient gas.
- Be sure the batteries are fully charged.
- Inspect the resuscitator.
- Inspect the Mobile Cart for damage.
- Be sure that the support arm is folded before transport.

2.5.2 DURING INTRAHOSPITAL TRANSPORT

While transporting the ventilator with or without a patient connected, follow facility guidelines and:

- Use the handles on the Mobile Cart.
- Transport the bed and the ventilator slowly, and watch the patient connection carefully to see that no pulling or other movement occurs.
- When moving the Support Arm or changing position, watch the patient connection carefully to see that no pulling or other movement occurs.
- Be careful not to tip the Mobile Cart when crossing an obstacle like a doorstep.

2.5.3 STORAGE

- When the SERVO-s Ventilator System is in storage, keep the ventilator connected to mains power to maintain full charge in the batteries.
- Do not dispose of battery modules and O₂ cells with ordinary waste.
- Be sure the system is not exposed to temperatures below +10°C or above +40°C.
- Be sure the system is not exposed to a relative humidity above 95%.

3 POWER SUPPLY

TABLE OF CONTENTS

3.1	Introduction		36
3.2	Viewing battery status		36
3.3	Alarms and safety		38

3.1 INTRODUCTION

The SERVO-s Ventilator System is equipped with an AC power supply with automatic range selection. The ventilator will automatically operate correctly using 100-120V AC or 220 - 240V AC outlets.

See chapter Technical data on page 145.

The ventilator is equipped with battery modules which automatically supply 12V DC power in the event of an AC power failure, ensuring that ventilator settings and stored data remain intact.

The ventilator also comes equipped with an inlet for an external 12V DC power supply. This power supply activates automatically in case of an AC power failure, and ventilator settings and stored data remain intact.

Two fixed battery modules are installed, providing one hour of back-up operation.

When the system is connected to an external power supply, all connected battery modules are being recharged. This does not affect ventilation.

Alarms and Messages

See *Alarms and Safety* on page 38.

When the ventilator is turned off with the on/off switch, batteries continue to charge.

3.2 VIEWING BATTERY STATUS

When operating from batteries, the estimated remaining battery time in minutes is displayed in the upper right corner of the screen on the *Status* touchpad.

WARNING! If the remaining battery time on the *Status* touch pad is displayed in red, the battery modules have very little operational time left and battery modules must be replaced. If possible, connect the ventilator to AC power.

Note: The total usable backup time is the sum of the estimated operation time displayed for each battery module minus 10 minutes.

Detailed battery status information is available via the Battery Status Window:

1. Press the *Status* touchpad at the top-right of the user interface to display the *Status Window*.

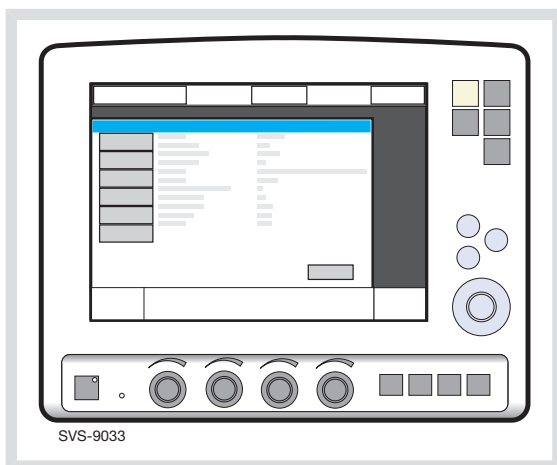

2. Press the *Batteries* touchpad to display the *Battery Status Window*.

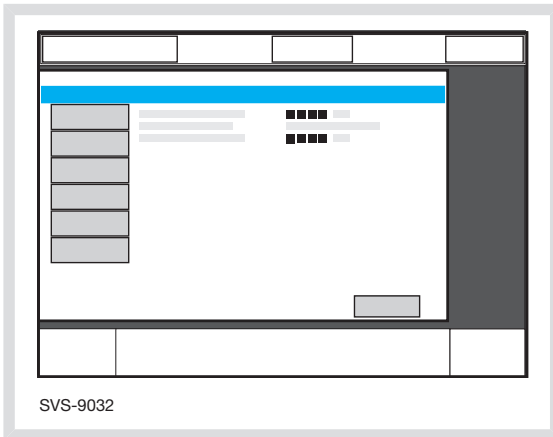

The following information is displayed for each mounted battery module:

- Slot number
- Serial number
- Charge indicator, where
 - 0 boxes filled = < 10% relative charge
 - 1 box filled = 10-25% relative charge
 - 2 boxes filled = 26-50% relative charge
 - 3 boxes filled = 51-75% relative charge
 - 4 boxes filled = 76-100% relative charge,
- Remaining operating time in minutes
- Activity Instruction—an instruction may be displayed next to the remaining operating time in minutes:

Activity Instruction	Response
<i>Expires soon</i>	Order a new battery module.
<i>Replace battery</i>	The battery is no longer reliable; replace it immediately.

3.3 ALARMS AND SAFETY

The status of the battery modules is continuously monitored by the ventilator. If the status is unsatisfactory, four types of messages may be displayed at the top of the user interface:

- Technical Error Message
- High Priority Alarm Message
- Medium Priority Alarm Message
- Text Message

3.3.1 WARNINGS

WARNINGS!

- If the *Replace battery* is displayed, the battery has become unreliable, regardless of the operating time displayed in the Battery Status Window. In this situation, replace the battery even when the status window indicates significant operating time remains.
- To guarantee reliable battery backup, two fully charged battery modules must be installed at all times.
- Always replace batteries when the ventilator software notifies you of imminent expiration or of diminished operating capacity.
- Dispose of batteries according to local regulations and not with ordinary waste.
- After a new battery module is installed, display the Battery Status Window to ensure safe battery operation.
- When delivered, the battery modules may not be fully charged. Check the status of the batteries via the user interface and, if necessary, charge the battery before use by connecting the ventilator to the power supply.
- Always recharge discharged batteries.
- When not in use, the ventilator should always be connected to the power supply to ensure fully charged batteries.

3.3.2 STATUS MESSAGES

Message (message type)	Explanation
<i>Technical error no. 1 - 6, 29, 10001</i> (technical error)	Power failure.
<i>Check battery status</i> (Text Message)	There is a problem with the battery modules. One or more battery modules must be replaced.
<i>Battery operation</i> (Medium Priority Alarm)	AC power is off line due to a power failure or disconnection.
<i>Limited battery capacity</i> (High Priority Alarm)	Less than 10 minutes left of battery operation.
<i>No battery capacity</i> (High Priority Alarm)	Less than 3 minutes left of battery operation.
<i>Low battery voltage</i> (High Priority Alarm)	Battery voltage too low. Cannot guarantee continued ventilator operation.

3.3.3 AC POWER FAILURE

In the event of an AC power failure or disconnection, the ventilator switches to battery operation and activates medium priority alarms, see Table above in Status Messages for details.

4 OPERATION OVERVIEW

TABLE OF CONTENTS

4.1	Workflow summary		42
4.2	Pre-use check		42
4.3	Patient circuit test		50
4.4	Enter the patient data		50
4.5	Select the Type of Ventilation (Options)		51
4.6	Set ventilation mode		52
4.7	Set alarm limits		53
4.8	Start ventilation		54
4.9	Additional settings window		55
4.10	Suctioning		56
4.11	Re-adjust the Oxygen cell		58
4.12	Disconnect the patient		58

4.1 WORKFLOW SUMMARY

The following summary procedure provides an overview of the operation of the SERVO-s Ventilator System.

1. Turn on the ventilator and perform a Pre-use check. When the ventilator is in Standby, a flashing message, *Patient not ventilated*, is displayed on the screen directly above the word Standby.
2. Enter data for the new patient, including height and weight.
3. Select type of ventilation (option).
4. Set the ventilation mode.
5. Check, and if necessary, adjust the alarm profile.
6. Connect ventilator to patient and start ventilation.
7. During ventilation you can:
 - use the *Additional Settings* and *Alarm profile* touchpads to review and adjust settings
 - use suction support
 - adjust the O₂ cell (not when O₂ sensor is used)
8. Disconnect the patient

The following sections describe each of the above steps in more detail.

4.2 PRE-USE CHECK

The Pre-use check includes tests and measurements of:

- internal technical functionality
- gas supply
- internal leakage
- pressure transducers
- safety valve
- O₂ cell / O₂ sensor
- flow transducers
- battery modules
- patient circuit leakage
- patient circuit compliance
- patient circuit resistance

WARNINGS!

- Always perform a Pre-use check before connecting the ventilator to a patient.
- The volume of the patient circuit used during Pre-use check should be the same as, and must never be higher than, during ventilation e.g. the active humidifier must be filled before Pre-use check.
- The separate Patient Circuit Test that can be performed in Standby does not replace the Pre-use check.
- If any malfunctions are detected during the start-up procedure, see chapter System messages for more information.
- Do not connect the ventilator to a patient while a malfunction persists.
- Do not disconnect the expiratory cassette while the ventilator is in operation; if necessary, disconnect the cassette while in Standby.

Important:

- If you change the breathing circuit after completion of the Pre-use check, perform a new Pre-use check or a patient circuit test.
- When the Pre-use check is completed, all possible sources of alarm signals have been verified and the alarm system operates correctly.

4.2.1 START-UP

1. Connect power and gas supplies:
 - Power: AC outlet
 - Gas: Air and O₂

CAUTION: Ensure that the cable to the User Interface is never disconnected while the SERVO-s Ventilator System is powered on.

2. Turn the ventilator on.

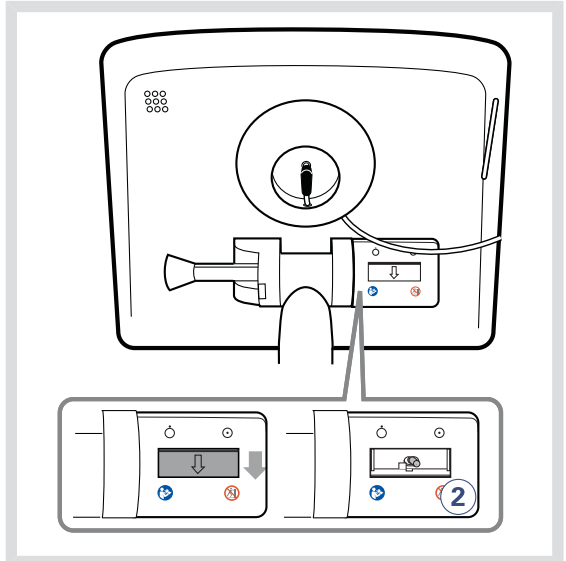

3. Start the Pre-use check by pressing Yes.

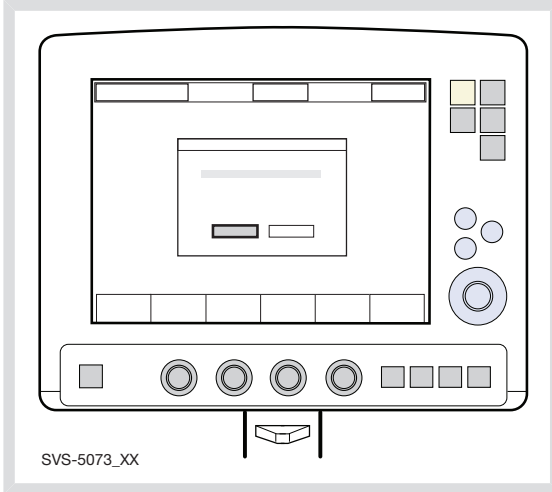

4. Follow the on-screen instructions.
5. After pressing the touchpad *Pre-use check* the message *Do you want to start a pre-use check?* is displayed - confirm by pressing Yes.

4.2.2 INTERNAL LEAKAGE TEST

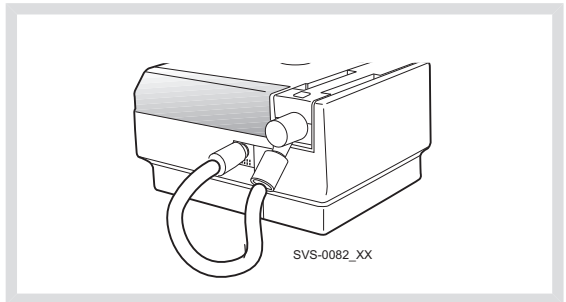

Connect the test tube between the inspiratory outlet and the expiratory inlet.

Important: Use only the MAQUET test tube.

4.2.3 BATTERY SWITCH TEST

The Pre-use check tests the ventilator's ability to switch between AC and battery power when AC power is lost and restored:

- When the on-screen instruction appears, disconnect the ventilator from AC power.
- When the on-screen instruction appears, reconnect the ventilator to AC power.

Note: This test will not be performed if there is less than 10 minutes of battery operation available.

4.2.4 PATIENT CIRCUIT TEST

The test measures the compliance and resistance of the patient breathing system.

The patient circuit resistance is automatically measured to determine if the ventilator maintains the specified accuracy with the connected breathing circuit.

1. Connect the complete breathing system to be used on the patient. If an active humidifier is used, it must be filled with water.

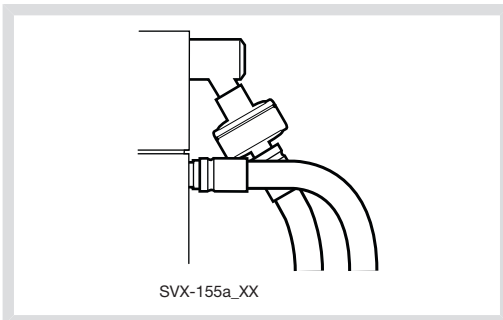

Important: When blocking the end of the complete breathing system, make sure there is no leakage. Leakage will affect the circuit compliance compensation calculation.

2. Block the end of the complete breathing system and follow the on-screen instructions. The circuit compliance and resistance are automatically measured. Go to Compensate for Circuit compliance (see page 46).

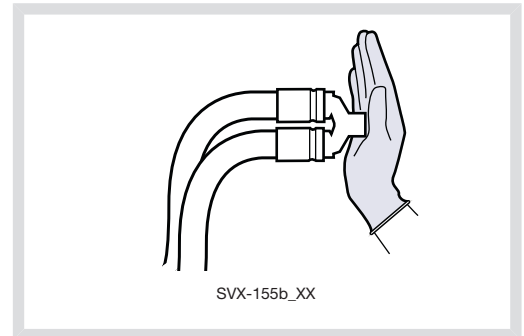

3. Unblock the end of the complete breathing system and follow the on-screen instructions.

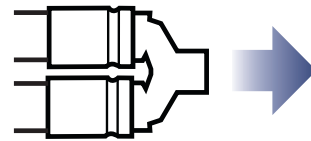

4.2.5 COMPENSATE FOR CIRCUIT COMPLIANCE

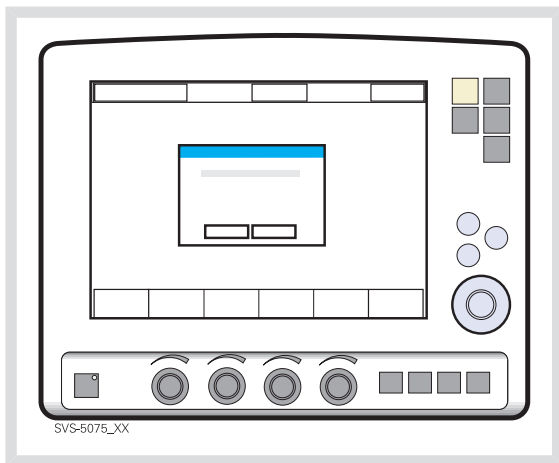

When the *Compensate for circuit compliance?* dialog appears on the screen, do one of the following:

- To add the compensation, press Yes (recommended),
- To refuse the compensation, press No.

Important: If the patient circuit is changed, a Patient Circuit Test must be performed.

Note: Circuit compliance compensation is not available in NIV modes (option).

4.2.6 TEST ALARM OUTPUT CONNECTION (OPTION)

If the Alarm Output Connection option is installed, a dialog for the external alarm system test appears on the screen.

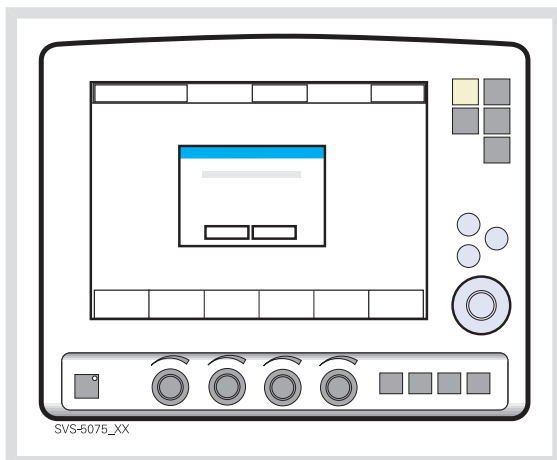

Do one of the following:

- To perform the test, press Yes and follow the on-screen instructions.
- To cancel the test, press No.

4.2.7 COMPLETE THE PRE-USE CHECK

A message appears on screen for each Pre-use check test, as appropriate: Cancelled, Failed, Not Completed, Passed or Running.

Press *OK* to confirm and to have the Pre-use check tests logged. The ventilator now switches to Standby.

Notes:

- After the Pre-use check is completed (or skipped), you will be prompted to keep or discard old patient-related data.
- By accessing the *Status* menu, the results of the two latest Pre-use checks are displayed under *General*.
- The status of the Patient Circuit test is displayed under *Status/ Patient Circuit*.

4.2.8 PRE-USE CHECK TESTS

Test	Description	Remedy if test fails
<i>Internal test</i>	Audio test and other internal tests (memory and safety-related hardware).	Make sure the patient unit front cover and the user interface rear cover are correctly mounted.
<i>Barometer test</i>	Checks the barometric pressure measured by the internal barometer.	Check the barometric pressure value in the Status Window.
<i>Gas supply test</i>	Checks that the gas supply pressures (air and O ₂) measured by the internal gas supply pressure transducers are within the specified range.	Check that the gas supply pressure (air and O ₂) is within the specified range. See page 146 for specification.
<i>Internal leakage test</i>	Checks for internal leakage, with test tube connected, using the inspiratory and expiratory pressure transducers. Allowed leakage: 10 ml/min at 80 cmH ₂ O.	If message <i>Leakage</i> or <i>Excessive leakage</i> appears: <ul style="list-style-type: none"> ■ check that the test tube is correctly connected, ■ check all connections for the expiratory cassette and inspiratory channel, ■ make sure the expiratory cassette and the inspiratory channel are clean and dry, OR ■ contact a service technician.
<i>Pressure transducer test</i>	Calibrates and checks the inspiratory and expiratory pressure transducers.	If the Internal leakage test passed (see above): <ul style="list-style-type: none"> ■ check/replace inspiratory or expiratory pressure transducer ■ check that there is no excess water in the expiratory cassette
<i>Safety valve test</i>	Checks and if necessary adjusts the opening pressure for the safety valve to 117 ± 3 cmH ₂ O.	Check the inspiratory section: <ul style="list-style-type: none"> ■ check that the safety valve membrane is correctly seated in the inspiratory pipe ■ check that the inspiratory pipe is correctly mounted in inspiratory section ■ check that the safety valve closes properly when the Pre-use check is started (distinct clicking sound from the valve)

Test	Description	Remedy if test fails
<i>O₂ cell / sensor test</i>	<p>Calibrates and checks the O₂ cell / sensor at 21% O₂ and 100% O₂. Checks if the O₂ cell is worn out.</p> <p>Because different gas mixtures are required for this test, it will not be performed if one gas is missing.</p>	<ul style="list-style-type: none"> ■ Check that the connected gas supply pressure (air and O₂) is within the specified range. ■ Replace the O₂ cell. ■ Replace gas modules (air and/or O₂).
<i>Flow transducer test</i>	<p>Checks the inspiratory flow transducers. Calibrates and checks the expiratory flow transducer.</p>	<ul style="list-style-type: none"> ■ Check that the connected gas supply pressure (air and O₂) is within the specified range. ■ Check that the cassette is correctly seated in the cassette compartment.
<i>Battery switch test</i>	<p>Tests switching to battery power when AC power is lost and back to AC power when it is restored.</p>	<p>Check that the total remaining time for the connected battery modules are at least 10 minutes. If not, replace the discharged battery with a fully charged battery and repeat the test.</p>
<i>Patient circuit test</i>	<p>Checks the patient circuit leakage, compliance and resistance, with patient tubing connected, using the inspiratory and expiratory pressure transducers.</p> <p>Allowed leakage: 80 ml/min at 50 cmH₂O.</p> <p>Will allow the system to calculate a compensation for circuit compliance (if the leakage requirements are met).</p> <p>Checks the patient circuit resistance, with patient tubing connected, using the inspiratory and expiratory pressure transducers.</p> <p>For ranges and accuracies, see chapter Technical data on page 148.</p>	<p>If the internal leakage test has passed, the leakage is located in the patient circuit. Check for leakage or replace the patient circuit.</p>
<i>Alarm state test</i>	<p>Checks that no Technical error alarms are active during the Pre-use check</p>	<p>Refer to service technician.</p>
<i>Alarm output connection</i>	<p>Checks that the alarm activation functions correctly.</p>	<ul style="list-style-type: none"> ■ Check that the cable is connected to the external system. ■ Refer to service technician.

4.3 PATIENT CIRCUIT TEST

In Standby, the Patient circuit test may be performed separately from the Pre-use check. This is useful, for example, when changes are made to the circuit or additional accessories are connected. The test evaluates circuit leakage and measures circuit compliance and resistance.

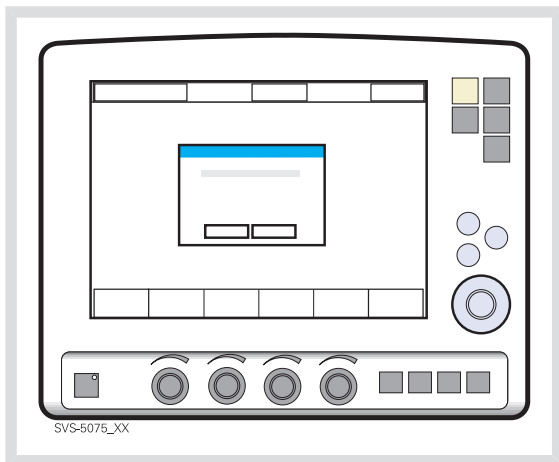

Press the *Patient circuit test* touchpad and follow the on-screen instructions.

Follow the instructions in section Patient circuit test.

The results from the Patient circuit test is displayed in the *Status>Patient circuit* window.

WARNINGS!

- A Pre-use check must always be done before connecting the ventilator to a patient.
- The Patient circuit test does not replace the Pre-use check.

4.4 ENTER THE PATIENT DATA

1. Press the *Admit patient* touchpad.
2. Activate touchpads by turning and pressing the Main Rotary Dial or by pressing the appropriate touchpads.

Enter/edit the following characteristics:

3. Patient name
4. Identity number
5. Date of birth
6. Date of admission
7. Body height
8. Body weight
9. Press, for example, *Name* to enter the patient's name.
10. Press *Close keyboard* when entry is complete.
11. When the ID touchpad is pressed, a keypad appears in the window.
12. Press *Accept* to confirm new data or *Cancel* to cancel new data.

PROCEDURE DIAGRAM: ENTER PATIENT DATA

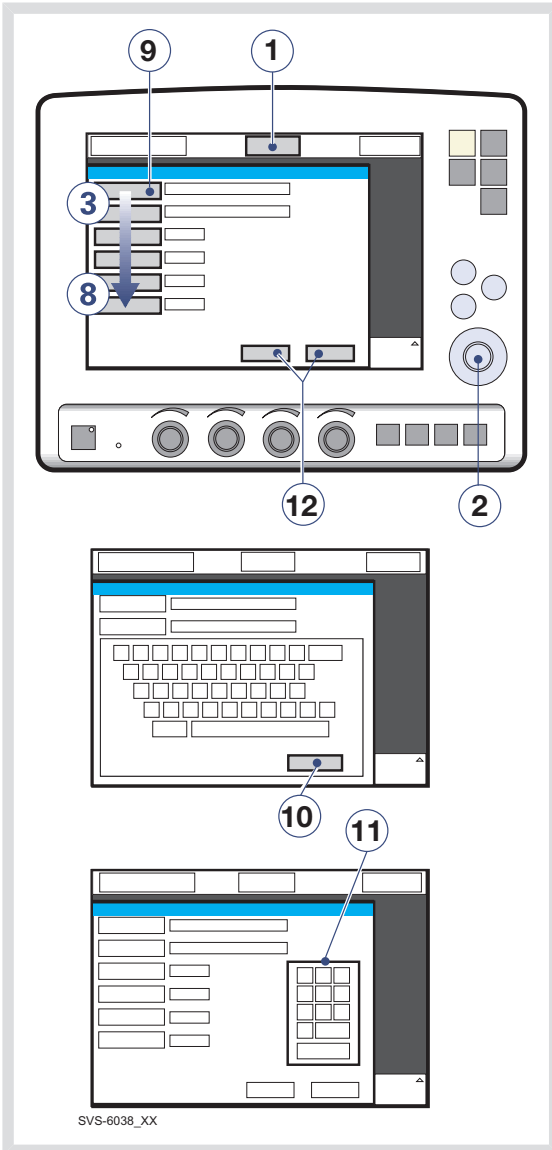

Important:

- Weights are in kilograms.
- Copy patient data before you enter a new name or ID, otherwise all data corresponding to the previous patient will be lost.
- The calculation of tidal and minute volume is based on entered body weight. If you omit this data, default values will be used for ventilation. An automatic calculation of Tidal Volume (based on body weight and immediately executed) will be performed only if the system is configured for *Tidal Volume based on body weight*.

4.5 SELECT THE TYPE OF VENTILATION (OPTIONS)

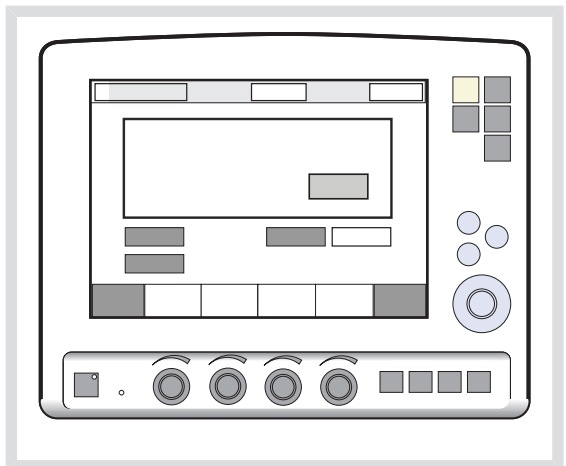

Press *Invasive ventilation* or *NIV (Non invasive ventilation)*.

Note: The default values may have been changed by a previous user.

4.6 SET VENTILATION MODE

To set ventilation mode and parameters:

1. Press the *Mode* touchpad.
2. Press the arrow at the active Mode touchpad.
Available ventilation modes appear.
3. Press the touchpad for desired mode of ventilation.

Note: If the type of ventilation is set to NIV(option), the only available modes are NIV Pressure Support and NIV Pressure Control.

4. When a ventilation mode has been selected, all related parameters can be set in the same window. Calculations are also displayed in this window.
5. Values are adjusted by turning the Main Rotary Dial.
6. Confirm each setting by pressing the parameter touchpad or pressing the Main Rotary Dial.
7. To activate all settings in the window press *Accept*, or to cancel the settings press *Cancel*.

PROCEDURE DIAGRAM: SET VENTILATION MODE

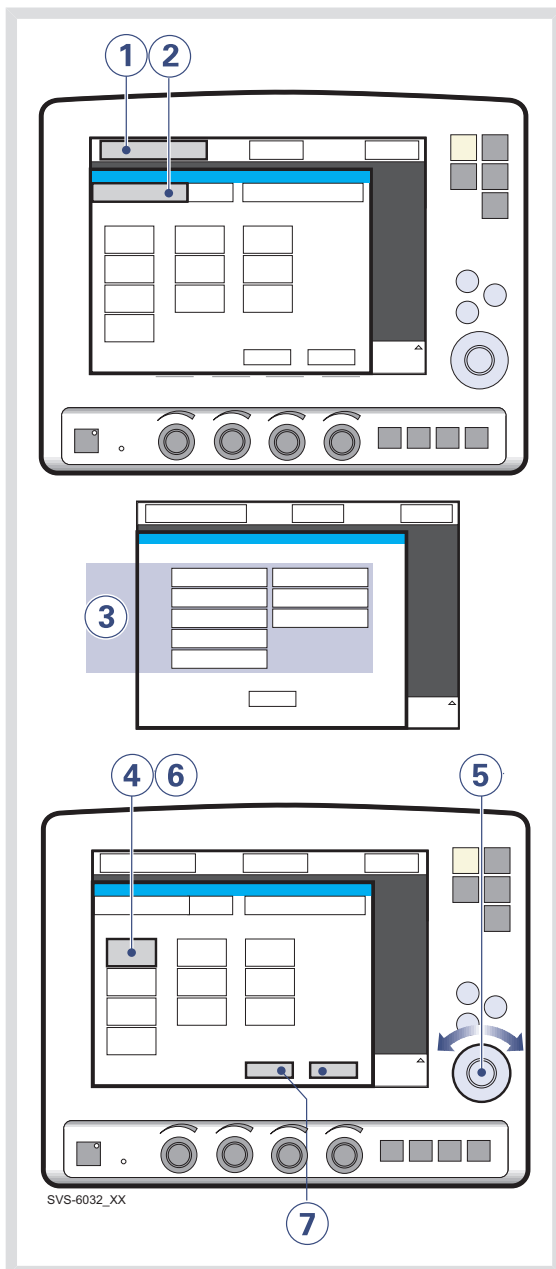

4.7 SET ALARM LIMITS

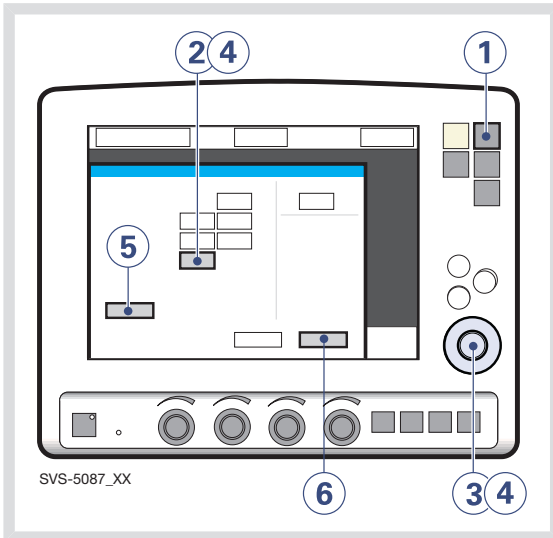

To set alarm limits:

1. Press the *Alarm Profile* fixed key.
2. Press the touchpad corresponding to the alarm limit you want to adjust or press the *Alarm sound level* touchpad.
3. Turn the Main Rotary Dial to adjust values.
4. Confirm each setting by pressing the parameter touchpad or Main Rotary Dial.

5. Press *Autoset*, if desired, to get a proposal for alarm limits in VC, PC, and PRVC modes.

Important: Before accepting *Autoset* values, make sure they are appropriate for the patient. If not, enter settings manually.

6. Press *Accept* to activate the new alarm limits.

Important: Before accepting *Autoset* values, make sure they are appropriate for the patient. If not, enter settings manually.

Notes:

- *Autoset* is not possible in Standby because the ventilator requires patient values in order to propose alarm limits.
- *Autoset* is not available in supported or NIV (optional) modes.
- Current alarm limits are displayed during ventilation in smaller figures to the right of the parameter display.
- The Main Rotary Dial becomes inoperative for 2 seconds when a defined safety limit for the alarm limit being adjusted is reached. After this, it will be operable again.

4.8 START VENTILATION

The *Start/Standby* key is used to start and stop both invasive and non invasive ventilation. It is also possible in Standby to start ventilation by pressing the *Start ventilation* touchpad on the screen.

WARNING! Make sure that ventilation is started when a patient is connected to the ventilator. When the ventilator is in Standby, a flashing message, *Patient not ventilated*, is displayed as a reminder directly above the word Standby.

4.8.1 START INVASIVE VENTILATION

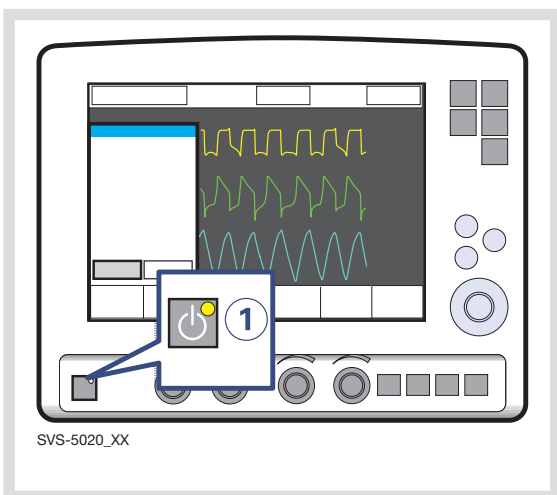

1. When the system is configured for invasive ventilation press the *Start/Standby* key (1) to start ventilation, or press the *Start ventilation* touchpad on the screen.

4.8.2 START NON INVASIVE VENTILATION (NIV) (OPTION)

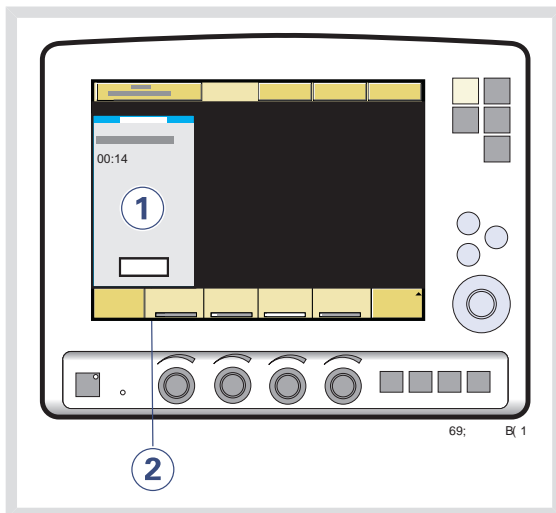

1. When the *Start/Standby* key is pressed and the SERVO-s Ventilator System is configured for NIV, a waiting position dialog is shown.

Note: All patient-related alarms are turned off for 120 seconds.

2. Press the *Start ventilation* touchpad.

Note: Ventilation starts automatically upon patient effort.

4.9 ADDITIONAL SETTINGS WINDOW

To adjust breathing parameters during ventilation, press the *Additional settings* touchpad to open the Additional Settings Window.

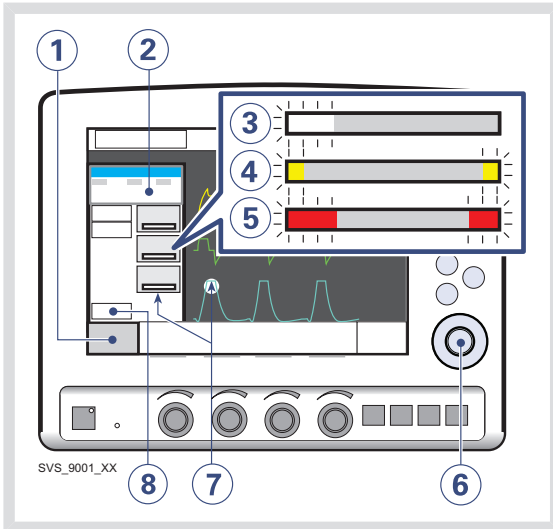

1. The *Additional settings* touchpad is in the lower left corner of the screen.
2. Values derived from settings such as inspiration time in seconds and calculated inspiratory flow are displayed.
3. A white bar indicates that the selected setting is within generally recognized safety limits.
4. A yellow (advisory) bar indicates that the selected setting is beyond generally recognized safety limits (this warning is accompanied by an audio signal and text message).

5. A red (warning) bar indicates that the selected setting is significantly beyond generally recognized safety limits (this warning is accompanied by an audio signal and text message).
6. Turning and pressing the Main Rotary Dial allows you to select settings and adjust values.

Note: New settings are effective from the first breath after adjustment (when the touchpad is deactivated).

7. The waveforms and measured values are displayed. Thus, the effects of the adjustments made can be checked immediately.
8. The *Close* touchpad closes the Additional Settings Window.

Note: The trigger sensitivity bar has different colors based on the setting. A green bar indicates a normal setting for flow triggering. The risk of self-triggering increases when the bar is red. A white bar indicates pressure triggering.

4.10 SUCTIONING

4.10.1 SUCTION SUPPORT

The Suction Support function makes it possible to automatically inhibit the ventilator from cycling during a tracheal suction procedure without activating alarms.

Suction Support includes:

- pre-oxygenation/preparation phase
- disconnect phase
- post-oxygenation phase

WARNINGS!

- Suction Support is not intended to be used together with closed-suction systems.
- The minimum PEEP level during suction support is 3 cmH₂O. The ventilator will adjust to the minimum level if the PEEP level is below 3 cmH₂O in order to detect disconnection of the patient.

Important: Alarms are turned off during the disconnect phase for a maximum of 60 seconds. If the patient has not been reconnected within 60 seconds, alarms are activated.

Notes:

- Suction Support is not available in NIV mode or when the *O₂ Breaths* function is activated.
- During the disconnect phase in Suction Support, the nebulizer is temporarily paused.
- When only one gas is connected, an elevated oxygen level cannot be set during the preparation phase. In this case, the post-oxygenation phase will be skipped.

4.10.2 PRE-OXYGENATION/PREPARATION PHASE

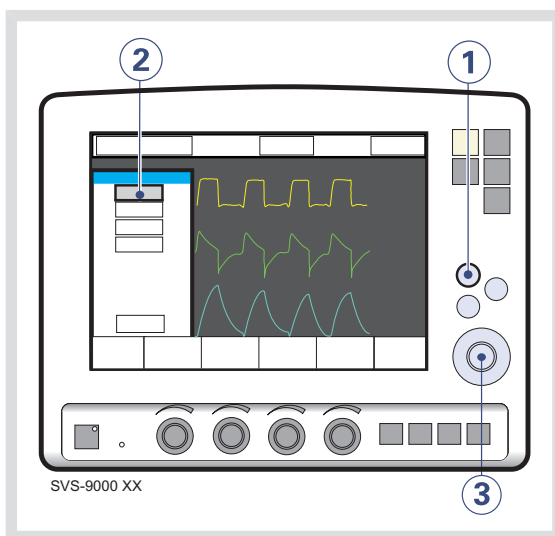

To enter the pre-oxygenation/preparation phase:

1. Press the *Quick access* fixed key.
2. Press the *Suction Support* touchpad.
3. Set the desired pre-oxygenation value by turning the *Main Rotary Dial* and press *Accept*.

The *Check tubing* alarm is turned off: the maximum duration of the preparation phase is 120 seconds. After 120 seconds, the system automatically returns to ventilation using the previous oxygen setting.

Note: The *Cancel* touchpad will close the Suction Support program.

4.10.3 DISCONNECT PHASE

The system automatically enters the disconnect phase when the patient is disconnected during the pre-oxygenation/preparation phase.

During the disconnect phase the following alarms are turned off for up to 60 seconds:

- Apnea
- Minute volume
- Respiratory rate
- PEEP

When the patient is reconnected, the system automatically enters the post-oxygenation phase and restarts ventilation.

It is also possible to restart ventilation manually by pressing the *Start ventilation* touchpad.

4.10.4 POST-OXYGENATION PHASE

After reconnection, the ventilator will deliver the same oxygen concentration as in the preparation phase for 60 seconds.

After 60 seconds the system automatically returns to ventilation using the previous oxygen setting.

4.10.5 CLOSED-SUCTION SYSTEMS

If a closed-suction system is used, the Suction Support, Insp. hold and Exp. hold functions should **not** be used. Pressure-based modes (such as Pressure Control, Pressure Support, Bi-Vent, or SIMV (PC) + PS) should be used. Settings should be adjusted to levels suitable for the patient. Hospital guidelines for suctioning should be followed.

4.11 RE-ADJUST THE OXYGEN CELL

Note: This does not apply if the SERVO-s Ventilator System has an O₂ sensor fitted.

If the ventilator has been in continuous use for an extended period, the measured O₂ concentration may drop due to normal degradation of the oxygen cell. In order to avoid nuisance alarms in this situation, it is possible to temporarily adjust the O₂ cell during ventilation.

When the *O₂ cell adaptation* function is activated, the oxygen cell is re-adjusted so that the current measured O₂ concentration is equal to the O₂ concentration set by the user. This temporary adjustment will be valid until the ventilator is switched off.

Important: Before using the SERVO-s Ventilator System, always perform a Pre-use check to make sure the O₂ cell is properly calibrated.

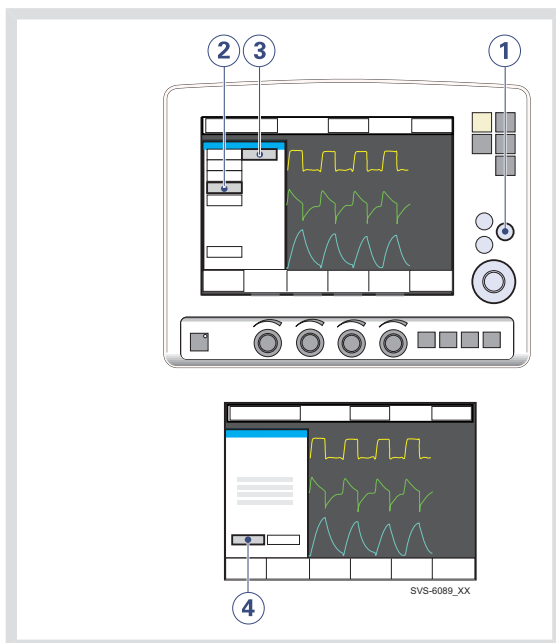

To re-adjust the O₂ cell:

1. Press the *Menu* fixed key.
2. Press the *Biomed* touchpad.
3. Press the *O₂ cell adaptation* touchpad.
4. Press the *Yes* touchpad to perform the O₂ cell adaptation.

4.12 DISCONNECT THE PATIENT

To disconnect and stop ventilation:

1. Physically disconnect the patient from the ventilator.
2. Press the *Start/Standby* key.
3. Press *Yes* to stop ventilation.
4. Turn the ventilator off using the On/Off switch behind the User Interface.

5 MONITOR AND RECORD

TABLE OF CONTENTS

5.1	Measured values display		60
5.2	Waveform display		62
5.3	Show event log		64
5.4	Show loops		64
5.5	Show trends		65

5.1 MEASURED VALUES DISPLAY

During ventilation, measured or calculated values of breathing parameters are displayed. This section describes the display, gives the procedure for displaying additional pages of measured and calculated values, and lists all viewable values.

5.1.1 DESCRIPTION

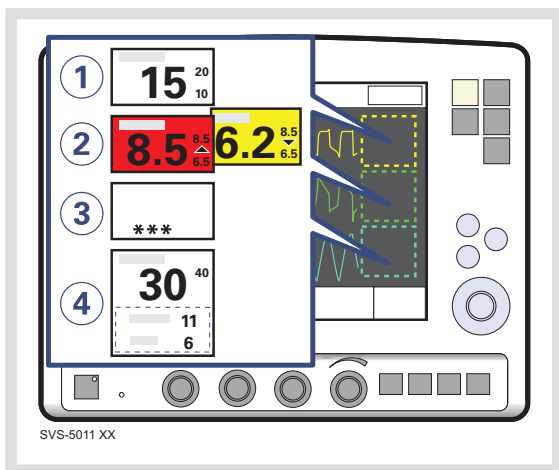

5.1.2 DISPLAY ADDITIONAL PAGES

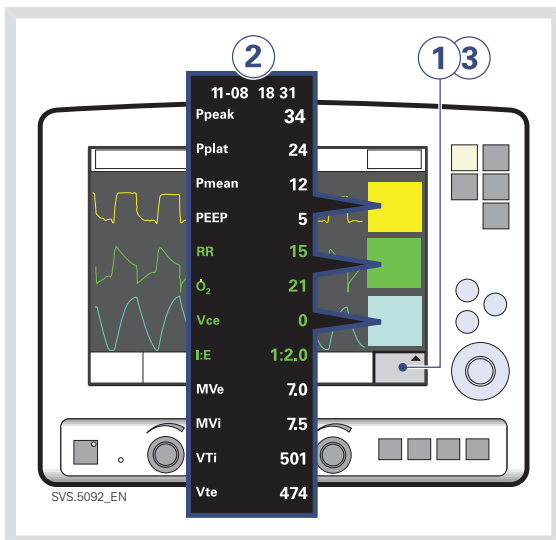

To view more values:

1. Press the *Additional values* touchpad in the lower right corner of the screen.
2. View desired values.
3. Press the *Additional values* touchpad again to view the next page of values.

Note: In NIV mode there is only one page of additional values.

Breathing parameter values are displayed on the right side of the screen.

Units are displayed.

1. Alarm limits are displayed in small digits.
2. An up or down arrow indicates whether the upper or lower alarm limit has been exceeded.
 - If a high priority alarm limit is exceeded, the box turns red.
 - If a medium priority alarm limit is exceeded, the box turns yellow.
3. Off-scale values are indicated by ***.
4. It is possible to change which values are displayed in the measured value boxes. (See Configuration chapter)

5.1.3 VALUES LIST

Values in boldface are shown on the first page by default.

P_{peak}	Maximum inspiratory pressure
P _{plat}	Pressure during end-inspiratory pause
P_{mean}	Mean airway pressure
PEEP	Positive end expiratory pressure
PEEP _{tot}	Set PEEP + Intrinsic PEEP
RR	Respiratory Rate
O₂	Measured oxygen concentration in vol.%
T _i	Inspiration time
T _c	Time constant
I:E	Inspiration to expiration ratio (during controlled ventilation)
T_i/T_{tot}	Duty cycle or ratio of inspiration time to total breathing cycle time (during spontaneous breathing and Bi-Vent).
MV _i	Inspiratory Minute Volume
MV_e	Expiratory Minute Volume
MV _e sp	Spontaneous expiratory minute volume (Bi-Vent)
MV _e sp / MV _e	The relation between spontaneous expired minute volume and total expired minute volume (Bi-Vent).
Leakage	Leakage % (NIV)
VT_i	Inspiratory Tidal Volume
VT_e	Expiratory Tidal Volume
V_{ee}	End expiratory flow
C _{dyn}	Dynamic characteristics
C _{static}	Static compliance, respiratory system
E	Elastance
R _i	Inspiratory resistance
R _e	Expiratory resistance
WOB _v	Work of breathing, ventilator
WOB _p	Work of breathing, patient
P0.1	Indicator for respiratory drive
SBI	Shallow Breathing Index

5.2 WAVEFORM DISPLAY

This section describes the waveform display and provides procedures for hiding and displaying the volume and for adjusting the sweep speed and scale of the waveforms.

The following color-coded waveforms are shown on the user interface screen by default:

- pressure time
- flow time
- volume time

5.2.1 DESCRIPTION

The default waveform display has the following characteristics:

- The value of a measured parameter vs. time is displayed.
- The displayed parameter and the scale are indicated on the y-axis.
- The pressure vs. time display is dark yellow.
- The flow vs. time display is green.
- The volume vs. time display is light blue.

5.2.2 SHOW AND HIDE

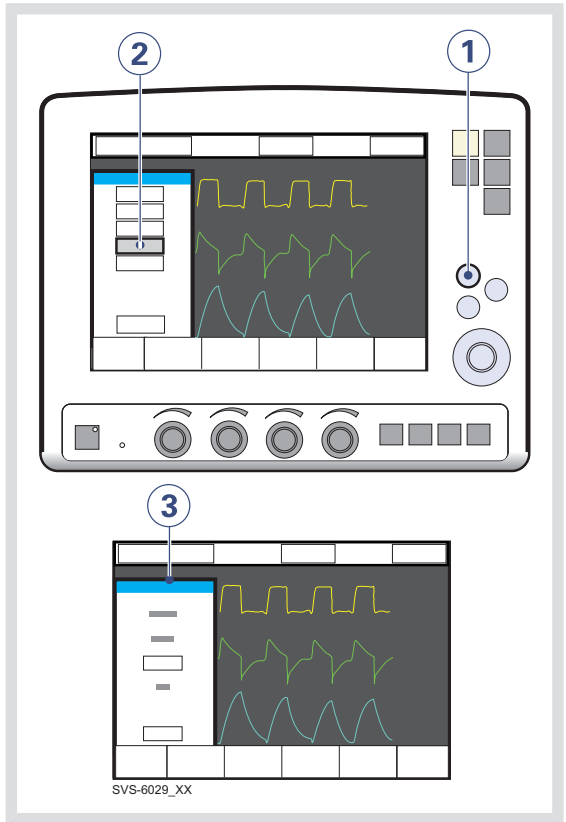

To show or hide the volume waveform:

1. Press the *Quick access* fixed key.
2. Press the *Waveform configuration* touchpad.
3. Press the touchpad corresponding to the waveform you wish to show or hide.

Notes:

- The pressure and flow waveforms are always displayed. The volume waveform may be hidden. Thus, 2 or 3 waveforms may be displayed.
- When you hide a waveform, the remaining waveforms are expanded to use all available screen space.

5.2.3 ADJUST SCALE/SWEEP SPEED

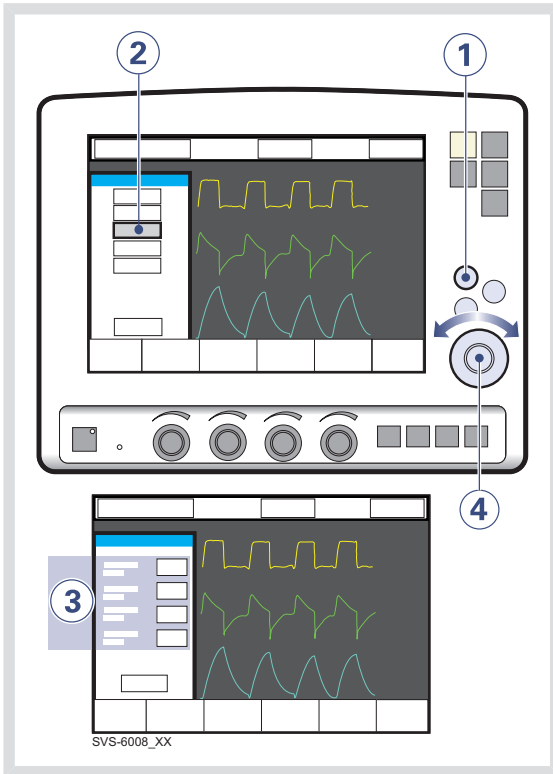

To set the sweep speed and amplitude for displayed waveforms:

1. Press the *Quick access* fixed key.
2. Press the *Waveform Scales* touchpad.
3. Press the touchpad corresponding to the waveform whose scale you wish to change or select a sweep speed (5, 10 or 20 mm/s).
4. To adjust the scale of a waveform, turn the Main Rotary Dial to the desired value or use auto scale (press *Auto*).

Important: MAQUET does not recommend using auto scale in Bi-Vent mode, when patient breathing is spontaneous on both levels.

5.3 SHOW EVENT LOG

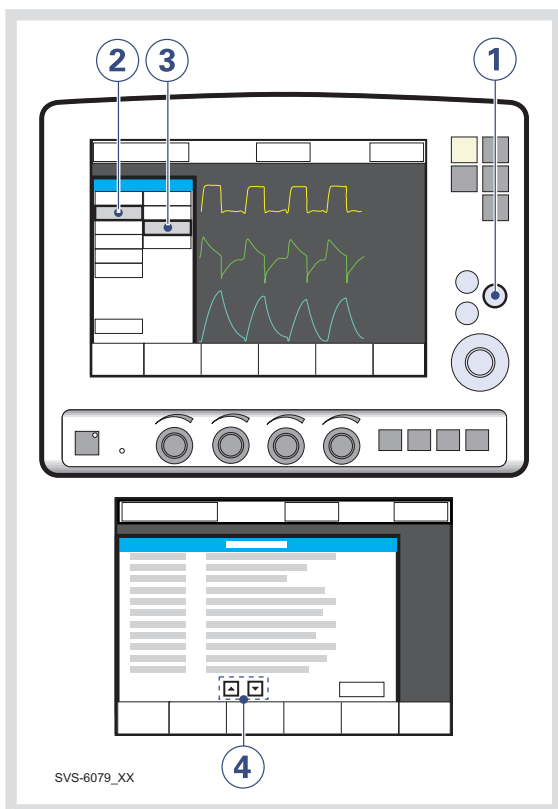

To view the Event Log:

1. Press the *Menu* fixed key.
2. Press the *Review* touchpad.
3. Press the *Event log* touchpad to view all logged events.
4. Use the arrows to scroll.

5.4 SHOW LOOPS

The Loops function provides a graphical representation of the relationship between flow-volume and pressure-volume.

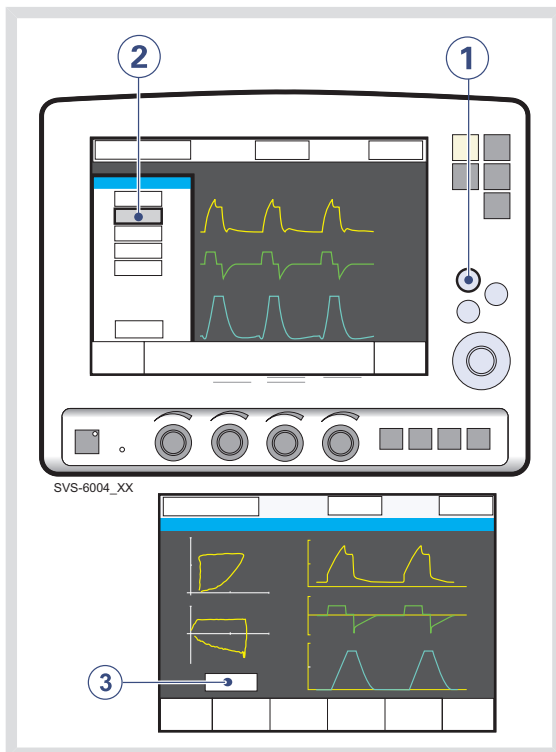

To activate the Loops function:

1. Press the *Quick access* fixed key.
2. Press the *Loops* touchpad
3. To close the window, press *Close*.

5.5 SHOW TRENDS

Trend values are stored every 60 seconds and retained as far back as 24 hours. Stored events and system changes are shown as event stamps.

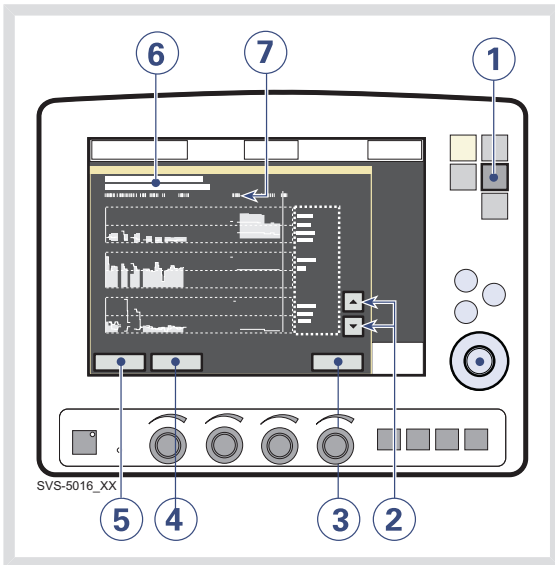

To show trends:

1. Press the *Trends* fixed key.
2. Use the up and down arrows to scroll between the different trend channels.
3. To quit the Trends Window press *Close*.
4. To adjust the time resolution press the *Hours* touchpad and turn the Main Rotary Dial.
5. Activate the *Cursor*. Move it back and forth on the time axis using the Main Rotary Dial or touch screen.
6. Time valid for the cursor position. For event stamps, an explanation appears.
7. Logged event stamps.

6 VENTILATION, MODES AND FUNCTIONS

TABLE OF CONTENTS

6.1	Introduction	68
6.2	Important definitions	70
6.3	Settings	72
6.4	Volume Control	78
6.5	Pressure Control	83
6.6	Pressure Regulated Volume Control	86
6.7	Pressure Support	89
6.8	Spontaneous/CPAP	92
6.9	SIMV	94
6.10	Bi-Vent	103
6.11	Non Invasive Ventilation	106
6.12	Backup ventilation	110
6.13	Ventilatory parameters - overview	113
6.14	Special functions	116

6.1 INTRODUCTION

The SERVO-s Ventilator System can operate in several different modes. This chapter describes the modes, their settings, and associated safety information.

It also summarizes special ventilatory functions, backup ventilation, and breathing parameters.

See the Technical data chapter for default values and allowed ranges for the breathing parameters.

Note:

The SERVO-s Ventilator System is delivered preset with the following configuration options:

- Breathing parameters are based on either Minute Volume or Tidal Volume.
- Breathing parameters are based on either I:E Ratio or Inspiration Time.

6.1.1 WARNINGS

Note: Not all warnings apply to all modes.

WARNINGS!

- Be sure to set alarm limits as appropriate for each mode. It is especially
 - Minute Volume Alarm
 - Apnea time
- Self-triggering should be avoided. Do not set the trigger sensitivity too high.
- To protect the patient's lungs from excessive pressure it is important to set the upper pressure limit to a suitable value.
- The following warnings apply to Non Invasive Ventilation (NIV) only:
 - Avoid high inspiratory pressure as it may lead to gastric overdistention and risk of aspiration. It may also cause excessive leakage.
 - Use of the Nebulizer is not recommended.

6.1.2 APPLICATION

The SERVO-s Ventilator System also contains tools to assist the user in application of lung recruitment methodologies.

6.1.3 SCOPE - VENTILATORY NEEDS

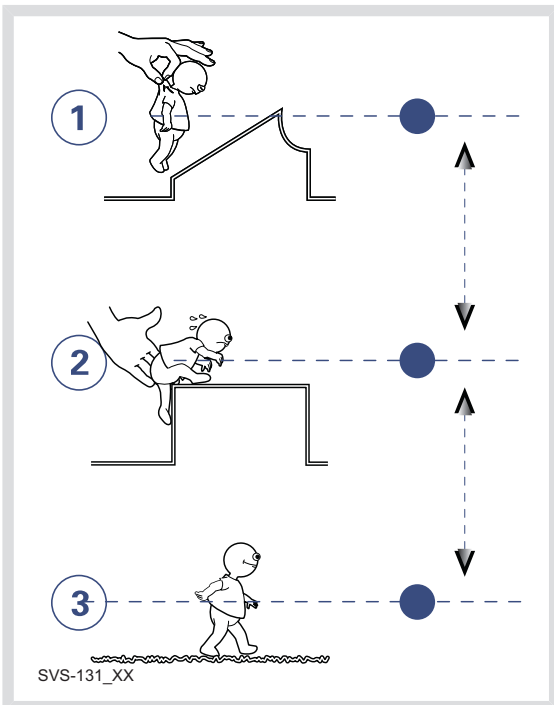

It also allows for combined ventilatory control or support. Spontaneous breathing efforts are sensed during controlled ventilation, e.g. Volume Control. Mandatory ventilation can be used during supported/spontaneous breathing, e.g. the enhanced SIMV functionality.

The ventilator can be used for:

1. controlled ventilation
2. supported ventilation, or
3. spontaneous breathing/CPAP

6.2 IMPORTANT DEFINITIONS

The graphic display of pressure, flow and volume is visualized in waveforms. Modes of ventilation directly affect flow, pressure and volume patterns.

6.2.1 VOLUME CONTROL

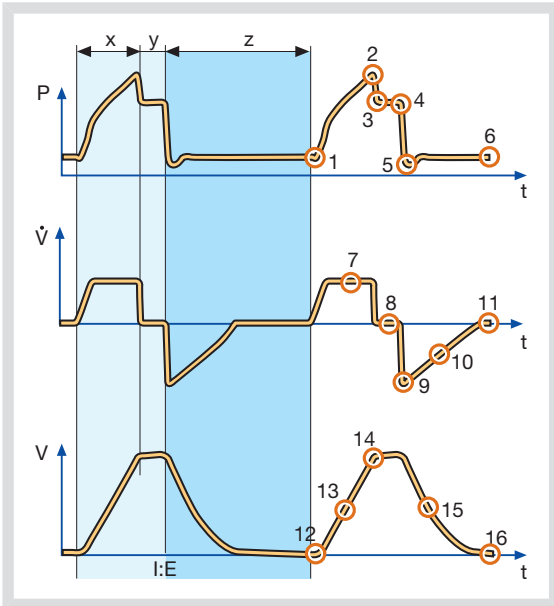

- X. Inspiration time
- Y. Pause time
- Z. Expiration time

PRESSURE-TIME WAVEFORM

1. Start of Inspiration
2. Peak inspiratory pressure
3. Early inspiratory pause pressure
4. End inspiratory pause pressure
5. Early expiratory pressure
6. End expiratory pressure

FLOW-TIME WAVEFORM

7. Peak inspiratory flow
8. Zero flow phase
9. Peak expiratory flow
10. Slope decelerating expiratory limb
11. End expiratory flow

VOLUME-TIME WAVEFORM

12. Start of inspiration
13. The slope represents current delivery of inspiratory tidal volume
14. End inspiration
15. The slope represents current patient delivery of expiratory tidal volume
16. End expiration

6.2.2 PRESSURE CONTROL

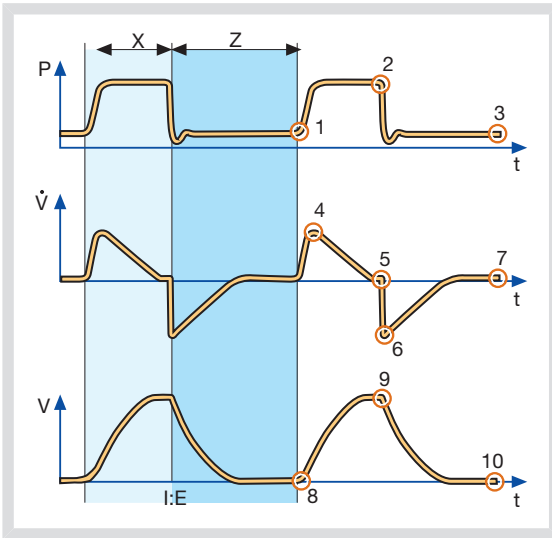

- X. Inspiration time
- Z. Expiration time

PRESSURE-TIME WAVEFORM

1. Start of Inspiration
2. Peak inspiratory pressure
3. End expiratory pressure

FLOW-TIME WAVEFORM

4. Peak inspiratory flow
5. End inspiratory flow
6. Peak expiratory flow
7. End expiratory flow

VOLUME-TIME WAVEFORM

8. Start of inspiration
9. End inspiration
10. End expiration

6.3 SETTINGS

6.3.1 TRIGGER FUNCTIONALITY

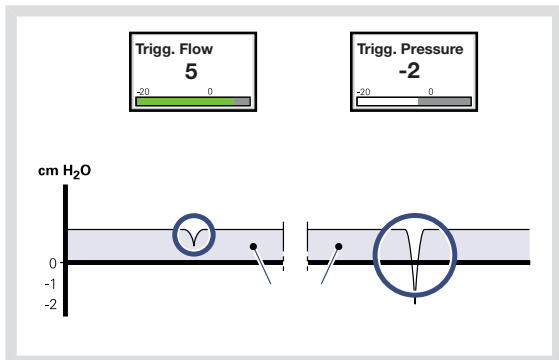

Trigger sensitivity determines the level of patient effort needed to trigger the ventilator to inspiration.

Trigger sensitivity can be set as flow triggering (settings above zero) or pressure triggering (settings below zero). Normally flow triggering is preferable as this enables the patient to breathe with less effort.

The sensitivity is set as high as possible without self-triggering. This ensures that triggering is patient initiated and avoids auto-cycling by the ventilator.

Important: In NIV it is not possible to set trigger sensitivity.

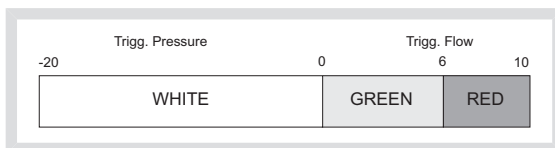

The trigger sensitivity bar has different colors based on the setting. A green bar indicates a normal setting for flow triggering. The risk of self-triggering increases when the bar is red. A white bar indicates pressure triggering.

WARNING! If the trigger sensitivity is set too high, a self triggering (auto-triggering) condition may be reached. This condition can also be reached if there is leakage in the breathing system, e.g. if an uncuffed endotracheal tube is used. Triggering will then be initiated by the system and not by the patient. This should always be avoided by decreasing the trigger sensitivity.

During expiration, the ventilator continuously delivers a gas flow (bias flow), which is measured in the expiratory channel. For details of the bias flow, see Technical data on page 149.

At a trigger sensitivity level above zero (0), The ventilator senses deviations in the bias flow delivered during expiration. These deviations are caused by the inspiratory efforts of the patient. The further to the right on the scale, the more sensitive is the trigger function.

At a trigger sensitivity level below zero (0), the ventilator senses deviations in the pressure below PEEP created by the patient. The pressure below PEEP required to initiate a breath is shown when the setting is made. The further to the left on the scale, the more effort is required to trigger.

6.3.2 INSPIRATORY RISE TIME

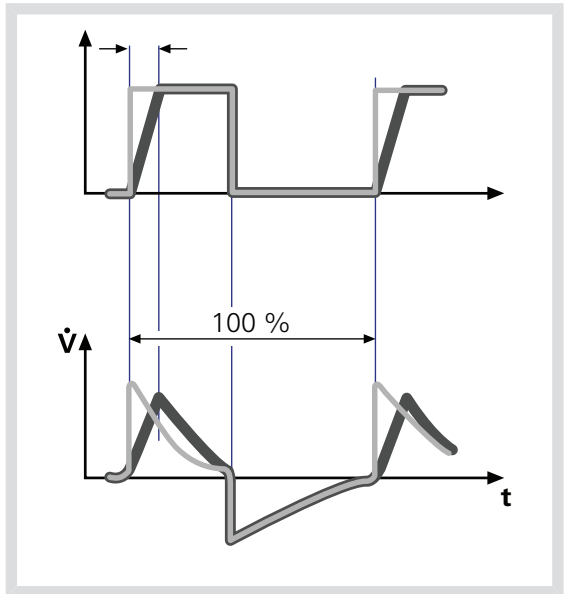

Time to peak inspiratory flow or pressure at the start of each breath as a percentage of the respiratory cycle time or in seconds. Increased rise time will affect the rate of flow/pressure increase and can be evaluated by the shape of the flow and pressure waveforms.

Inspiratory rise time (%) is applicable in Pressure Control, Volume Control, PRVC, SIMV-Volume Control, SIMV-Pressure Control, SIMV-PRVC. Setting can be in the range 0-20% of the respiratory cycle time.

Inspiratory rise time set in seconds is applicable in Pressure Support and Bi-Vent. The range is 0-0.4 seconds.

Note: When the ventilator is configured for setting of Inspiration time, the unit for Inspiratory rise time then automatically switches to seconds for all ventilation modes.

Normally in supported modes the Inspiratory rise time should be increased from the default setting and to give more comfort to the patient.

6.3.3 PEEP

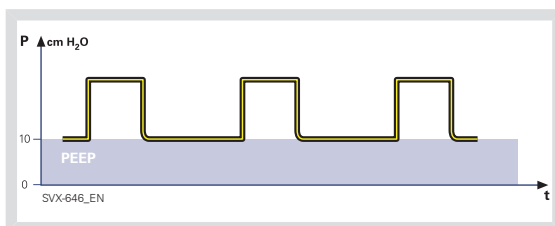

A Positive End Expiratory Pressure is maintained in the alveoli and may prevent the collapse of the airways.

For Positive End Expiratory Pressure setting ranges, see section Breathing parameters: default values & allowed settings (standard configuration) on page 152

6.3.4 I:E RATIO / INSPIRATION TIME

The setting of breathing parameters in SERVO-s Ventilator System can be configured in two different ways, based on:

- I:E ratio (independent of changes of e.g. the breathing frequency) or,
- Inspiration time in seconds (independent of changes of e.g. breathing frequency).

When the ventilator is configured for setting of Inspiration time, the unit for Pause time and Insp. rise time then automatically switches to seconds. The resulting I:E ratio for each setting is shown in the upper right information area of the ventilation mode window.

As the inspiration time is explicitly set, a change of for example the Respiratory Rate will affect the I:E ratio. As a safety precaution, it will therefore be indicated when the resulting I:E ratio passes 1:1 in either direction.

Note:

The touchpad Breath cycle time is not shown when an SIMV mode is selected, since there is no need to set Breath cycle time when Inspiration time is directly set. The configuration is done by a service technician with a service card.

6.3.5 INSPIRATORY CYCLE-OFF

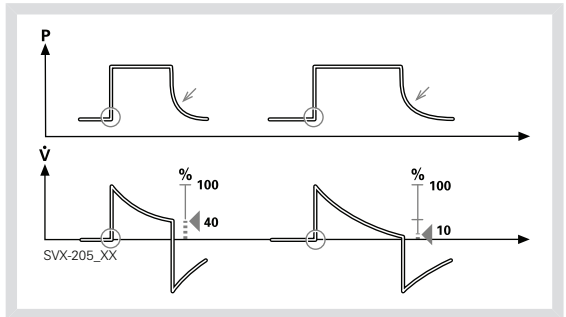

Inspiratory Cycle-off is the point at which inspiration changes to expiration in spontaneous and supported modes of ventilation. A decrease of the inspiratory flow to a preset level causes the ventilator to switch to expiration. This preset level is measured as a percentage of the maximum flow during inspiration.

For inspiratory cycle off setting ranges, see section Breathing parameters: default values & allowed settings (standard configuration) on page 151.

6.3.6 BREATH CYCLE TIME

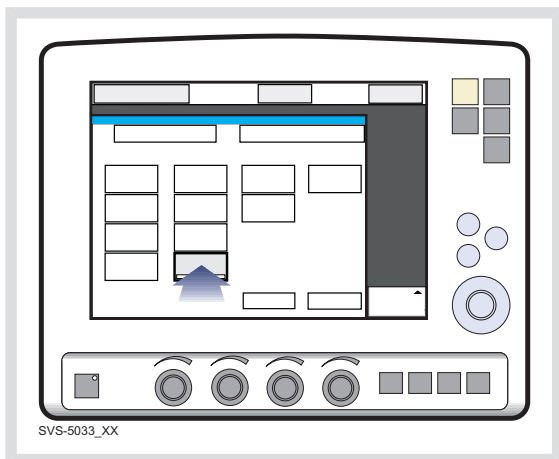

This is the length of the breath i.e. the total cycle time of the mandatory breath in SIMV (inspiration, pause plus expiration).

Note: The touchpad Breath cycle time is not shown when an SIMV mode is selected and inspiration time is configured. Refer to heading I:E ratio / Inspiration times.

6.3.7 VOLUME SETTING

Depending on the ventilator configuration the inspiratory volume can be set as:

- Minute Volume or,
- Tidal Volume

Note: The configuration is done by a service technician with a service card.

6.3.8 CONTROLLED / SUPPORTED PRESSURE LEVEL

PC (Pressure Control level) above PEEP is the set inspiratory pressure level for each mandatory breath in Pressure Control and SIMV (PC) + PS, and also for backup ventilation in Pressure Support.

PS (Pressure Support level) above PEEP is the set inspiratory pressure support level for triggered breaths in Pressure Support, SIMV modes and Bi-Vent.

6.3.9 O₂ CONCENTRATION

The setting range for the gas mixer is 21% O₂ to 100% O₂. The alarm limits are automatically set at approximately 5% O₂ above or below the set concentration value. The alarm is delayed 40 seconds after changing the O₂ concentration setting. There is also an absolute minimum alarm limit of 18% O₂ which is independent of operating settings.

6.3.10 RESPIRATORY RATE / SIMV RATE

Respiratory rate is the number of controlled mandatory breaths per minute in controlled modes excluding SIMV. The respiratory rate is also used for calculation of tidal volume if the ventilator is configured for Minute volume setting. SIMV rate is the number of controlled mandatory breaths in SIMV modes.

6.3.11 PREVIOUS MODE

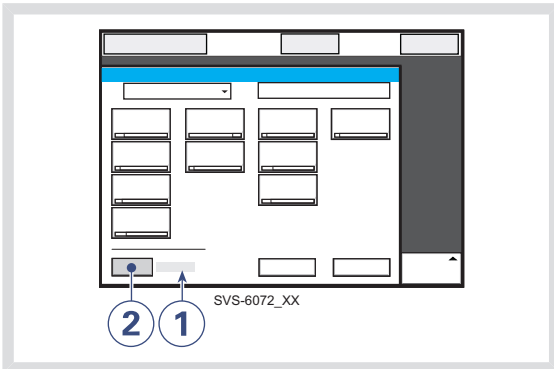

1. Time when previous mode was inactivated.
2. Press the touchpad Show previous mode to recall the previous accepted ventilation mode.

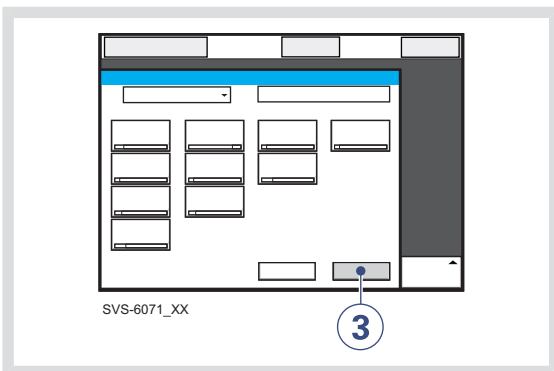

3. Activate the previous used ventilation mode settings by pressing the Accept touchpad.

Notes:

- The previous mode function is not available after a Pre-use check, changing of patient category, admitting a new patient, use of the same ventilation mode for more than 24 hours or after start-up (cold start) of the system.
- When "Previous Mode" is activated during Backup ventilation, the ventilator returns to the mode that was active before Support mode was initiated.
- A recall of previous settings is only possible after a change of ventilation mode.

6.4 VOLUME CONTROL

6.4.1 FUNCTIONAL DESCRIPTION VOLUME CONTROL

In the flow/volume oriented modes a controlled flow is used to maintain the set inspiratory Tidal Volume.

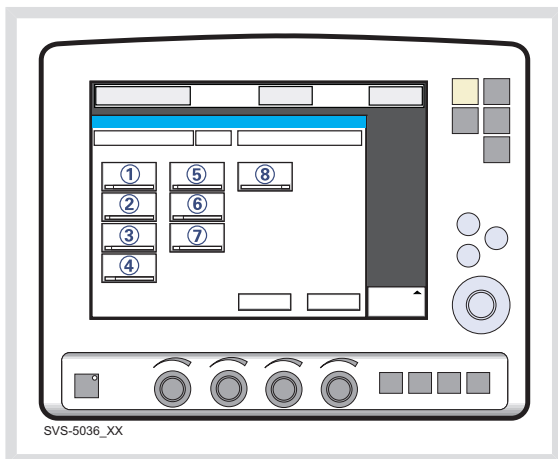

Volume Controlled ventilation ensures that the patient receives a certain pre-set Minute/Tidal Volume.

The SERVO-s Ventilator can be configured to set Tidal Volume or Minute Volume. The following parameters are set:

1. Tidal Volume (ml) or the Minute Volume (l/min)
2. Respiratory Rate (b/min)
3. PEEP (cmH₂O)
4. Oxygen concentration (%)
5. I:E ratio / Insp. time
6. Pause time (%/s)
7. Inspiratory rise time (%/s)
8. Trigg. Flow / Trigg. Pressure



The airway pressure is dependent on the tidal volume, inspiration time and the resistance and compliance of the respiratory system. The set tidal volume will always be delivered. An increase in the resistance and decrease in compliance will lead to an increased airway pressure. To protect the patient's lungs from excessive pressure, it is very important to set the upper pressure limit to a suitable value.

6.4.2 FLOW ADAPTATION

It is possible for the patient to trigger extra breaths if they can overcome the pre-set trigger sensitivity. It is also possible for the patient, by their own inspiratory efforts, to receive a higher inspiratory flow and Tidal Volume during an inspiration than pre-set. The flow during inspiration is constant. The patient can trigger extra breaths.

Volume Controlled ventilation has, by tradition, delivered each breath with a constant flow and constant inspiratory and expiratory times, according to the settings. The SERVO-s Ventilator System gives the possibility to the patient to modify both flow rate and timing. So, if a pressure drop of 3 cmH₂O is detected during inspiration, the ventilator cycles to Pressure Support with a resulting increase in inspiratory flow. When the flow decreases to the calculated target level this flow will be maintained until the set Tidal Volume is delivered.

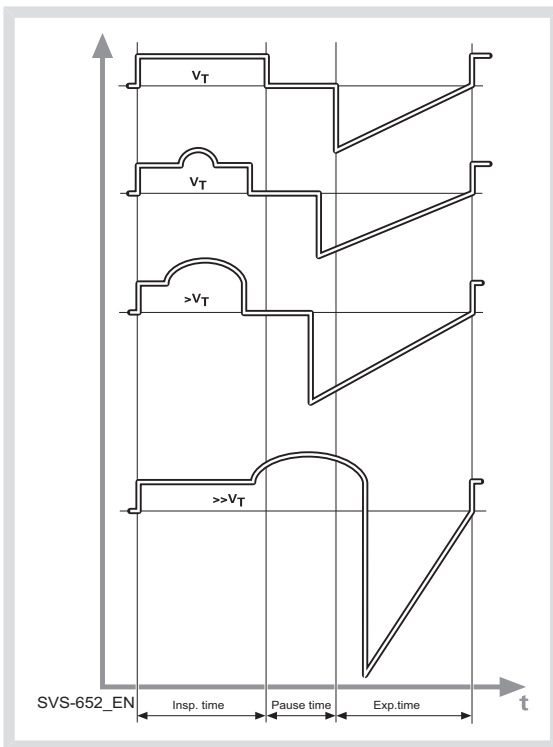

The illustrated waveform show some practical consequences of this enhanced functionality.

- the top waveform shows the trace for a normal Volume Controlled breath
- the second waveform shows a situation when inspiration is prematurely interrupted as the set tidal volume has been delivered
- the third waveform shows a situation where the patient maintains a flow rate higher than the calculated target value. The set Tidal Volume has been delivered when calculated target flow is reached and the inspiration is prematurely interrupted
- the bottom waveform, shows a situation where the increased flow rate is maintained into the expiratory period. The patient will receive a higher tidal volume than set due to a higher flow/volume demand than calculated.

6.4.3 VOLUME CONTROL IN DETAIL

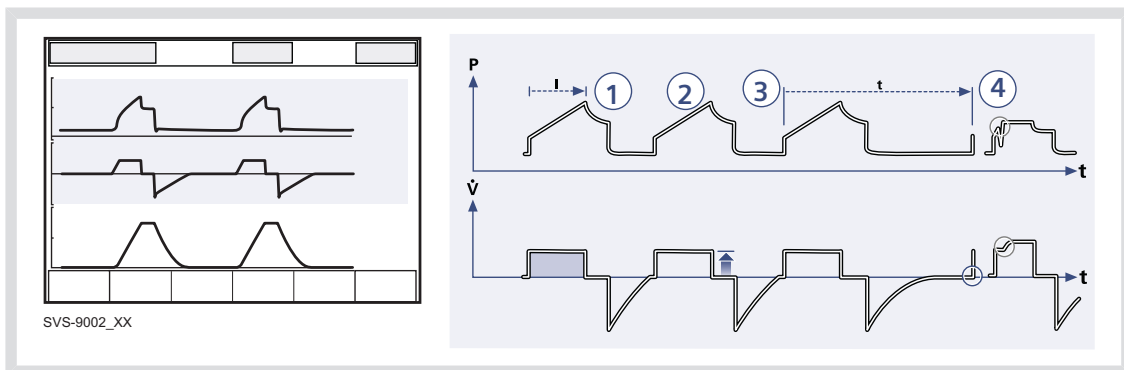

1. Volume Control assures a preset tidal volume with constant flow during a preset inspiratory time at a preset frequency.
2. The inspiratory flow is constant and depends on User Interface setting.
3. Inspiration starts according to the preset frequency or when the patient triggers.
4. If the patient makes an inspiratory effort during the inspiratory period, the ventilator will switch to Pressure Support to satisfy the patient's flow demand.

Expiration starts:

- When the preset tidal volume is delivered and after the preset pause time.
- When the flow returns to the set value after the preset tidal volume is delivered and after the preset pause time (on-demand support). The patient is however always guaranteed an expiration time corresponding to at least 20% of the total breath.
- If the upper pressure limit is exceeded.

6.4.4 VOLUME CONTROL WITH ALTERNATIVE FLOW PATTERNS

When the *Volume Control with alternative flow patterns* is **enabled** in the start-up configuration, new touchpads for setting of alternative flow patterns are available in Volume Control and SIMV (VC)+PS.

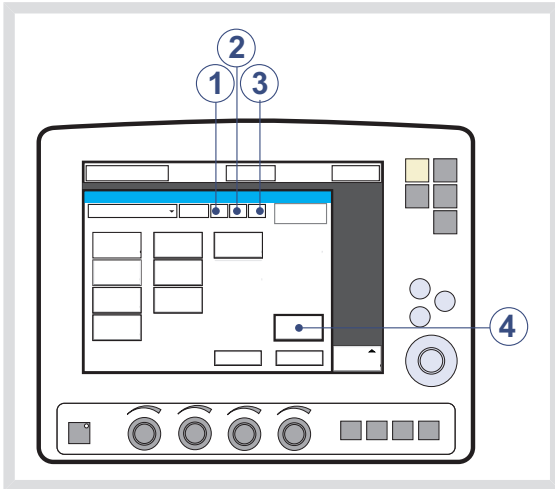

1. Volume control with flow adaptation
2. Volume control without flow adaptation
3. Volume control with decelerating flow
4. Flow pattern

See section User Interface Symbols on page 20.

Volume Control with flow adaptation

The ventilator interacts with the patient and delivers the extra volume requested regardless of the settings. See section Flow adaptation on page 78.

To ventilate with Volume Control with flow adaptation:

- Press the *Volume Control with flow adaptation* touchpad.
- Press *Accept*.

Volume Control without flow adaptation

The ventilator delivers volume strictly according to the settings.

To ventilate with Volume Control without flow adaptation:

- Press the *Volume control without flow adaptation* touchpad.
- Press *Accept*.

Note: Set trigger sensitivity at an adequate level. A patient who needs more ventilation may increase the breathing frequency instead of increasing the flow during inspiration.

Volume Control with decelerating flow

The ventilator delivers a decelerating flow according to *Flow pattern* settings.

To ventilate with decelerating flow:

- Press the *Volume control with decelerating flow* touchpad.
- Press the *Flow pattern* touchpad and set the flow pattern with the Main Rotary Dial. The flow pattern can be set so that the end inspiratory flow is 75 %, 50 % (default), 25 % or 0 % of the peak flow.
- Press *Accept*.

FLOW-TIME WAVEFORM

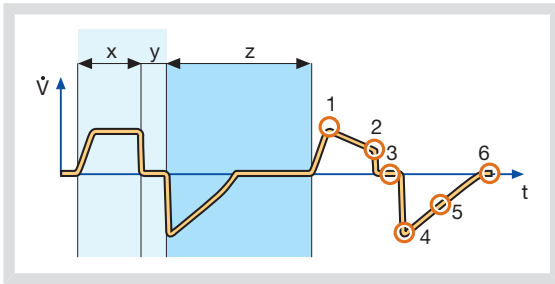

X. Inspiration time

Y. Pause time

Z. Expiration time

1. Peak inspiratory flow
2. End inspiratory flow
3. Zero flow phase
4. Peak expiratory flow
5. Slope decelerating expiratory limb
6. End expiratory flow

Notes:

- Flow adaptation is not enabled in *Volume Control with decelerating flow*. Set trigger sensitivity at an adequate level. A patient who needs more ventilation may increase the breathing frequency instead of increasing the flow during inspiration.
- The default setting of Pause time is 0 s.

6.5 PRESSURE CONTROL

6.5.1 FUNCTIONAL DESCRIPTION PRESSURE CONTROL

The Pressure Controlled mode is a controlled breathing mode.

Breaths are delivered mandatorily at a preset pressure level, causing a decelerating flow pattern.

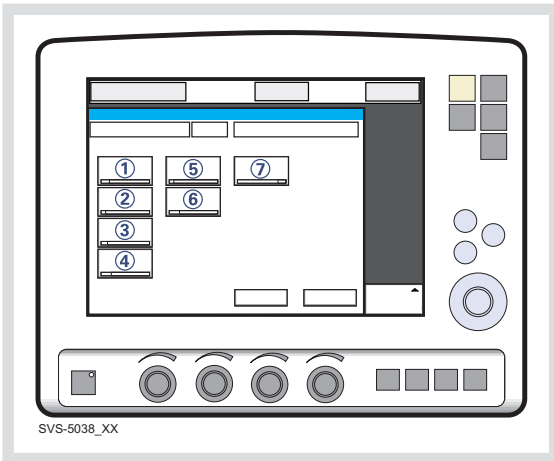

The following parameters are set:

1. PC (Pressure Control level) above PEEP (cmH₂O)
2. Respiratory Rate (b/min)
3. PEEP (cmH₂O)
4. Oxygen concentration (%)
5. I:E ratio / Insp. time
6. Inspiratory rise time (%/s)
7. Trigg. Flow / Trigg. Pressure

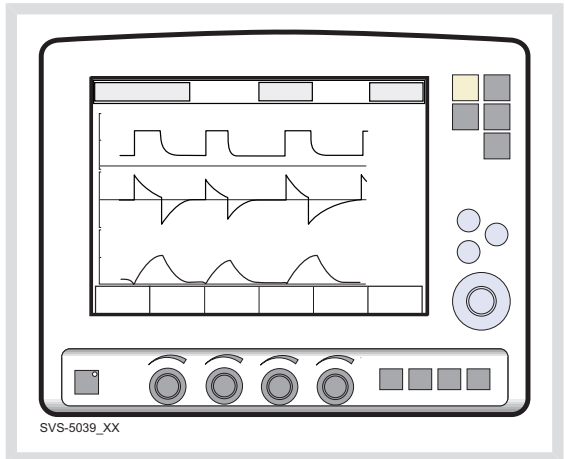

The delivered volume is dependent upon the pressure above PEEP, lung compliance and resistance in the patient tube system and airways. This means that the Tidal Volume can vary. Pressure Controlled mode is preferred when there is leakage in the breathing system e.g. due to uncuffed endotracheal tube or in situations when the maximum airway pressure must be controlled. The flow during inspiration is decelerating. The patient can trigger extra breaths. If the patient tries to exhale during the inspiration, the expiratory valve will allow exhalation as long as the pressure is more than 3 cmH₂O above the set pressure level. As the delivered tidal volume can vary it is very important to set alarm limits for Minute Volume to adequate levels.

6.5.2 PRESSURE CONTROL IN DETAIL

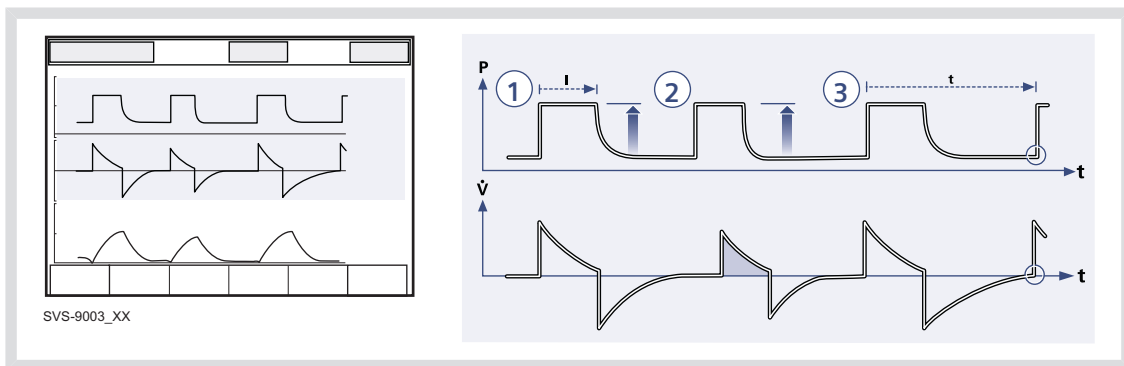

1. Pressure Control assures that the preset inspiratory pressure level is kept constant during the entire inspiration. Breaths are delivered according to the preset frequency, inspiration time and inspiratory pressure level resulting in a decelerating flow.
 - **Expiration starts:**
 - After the termination of preset inspiration time
 - If the upper pressure limit is exceeded.
2. The preset pressure level is controlled by the ventilator. The resulting volume depends on the set pressure level, inspiration time and the patient's lung mechanical properties during each breath with a decelerating flow.
3. Inspiration starts according to the preset frequency or when the patient triggers.

ACTIVE EXPIRATORY VALVE

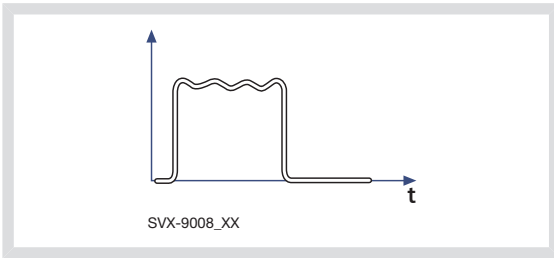

If a patient tries to exhale during the inspiration, pressure increases. When it increases 3 cmH₂O above the set inspiratory pressure level, the expiratory valve opens and regulates the pressure down to the set inspiratory pressure level.

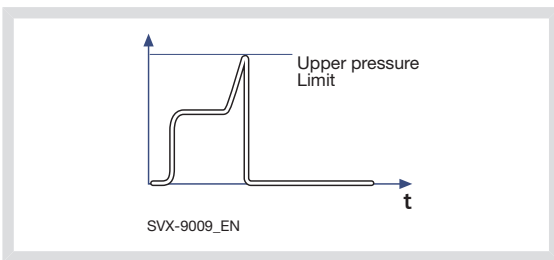

If the pressure increases to the set upper pressure limit e.g. the patient is coughing, the expiratory valve opens and the ventilator switches to expiration.

6.6 PRESSURE REGULATED VOLUME CONTROL

6.6.1 FUNCTIONAL DESCRIPTION PRVC

The Pressure Regulated Volume Control (PRVC) mode is a controlled breathing mode.

Breaths are delivered mandatorily to assure preset volumes, with a constant inspiratory pressure continuously adapting to the patient's condition. The flow pattern is decelerating.

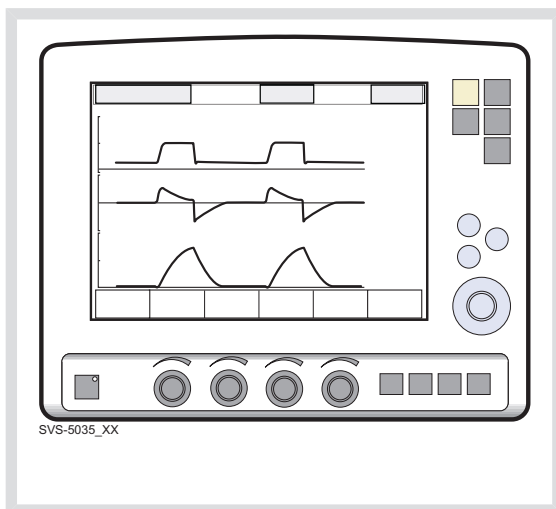

The ventilator delivers a pre-set Tidal Volume. The pressure is automatically regulated to deliver the pre-set volume but limited to 5 cmH₂O below the set upper pressure limit.

The flow during inspiration is decelerating. The patient can trigger extra breaths.

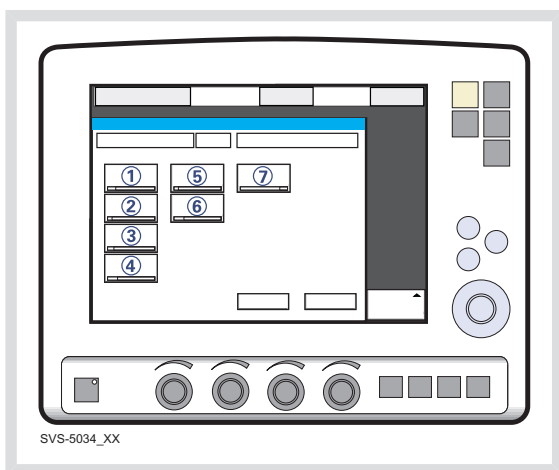

SERVO-s Ventilator System can be configured to set Tidal Volume or Minute Volume. The following parameters are set:

1. Tidal Volume (ml) or Minute Volume (l/min)
2. Respiratory Rate (b/min)
3. PEEP (cmH₂O)
4. Oxygen concentration (%)
5. I:E ratio / Insp. time
6. Inspiratory rise time (%/s)
7. Trigg. Flow / Trigg. Pressure

6.6.2 PRVC IN DETAIL

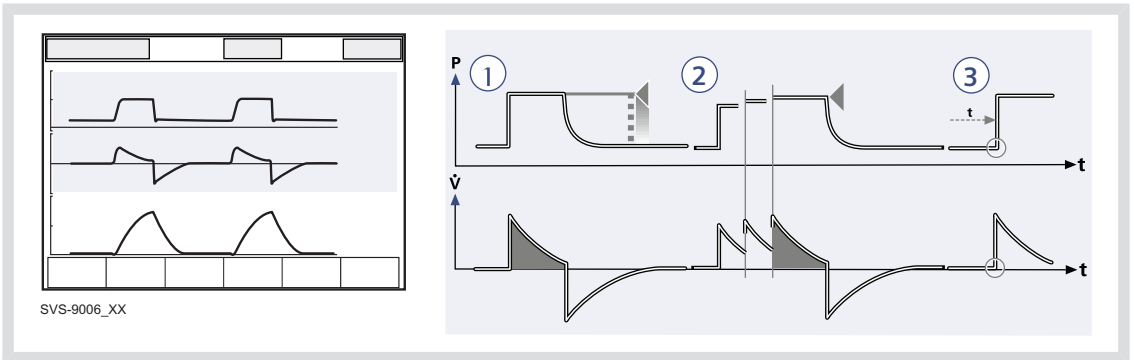

1. PRVC assures a set target minute ventilation to the patient. The target volume is based upon settings for Tidal Volume, frequency and inspiration time.
2. The inspiratory pressure level is constant during each breath, but automatically adapts in small increments breath-by-breath to match the patient's lung mechanical properties for target volume delivery.
3. Inspiration starts according to a preset frequency or when the patient triggers.

Expiration starts:

- After the termination of preset inspiration time
- If the upper pressure limit is exceeded.

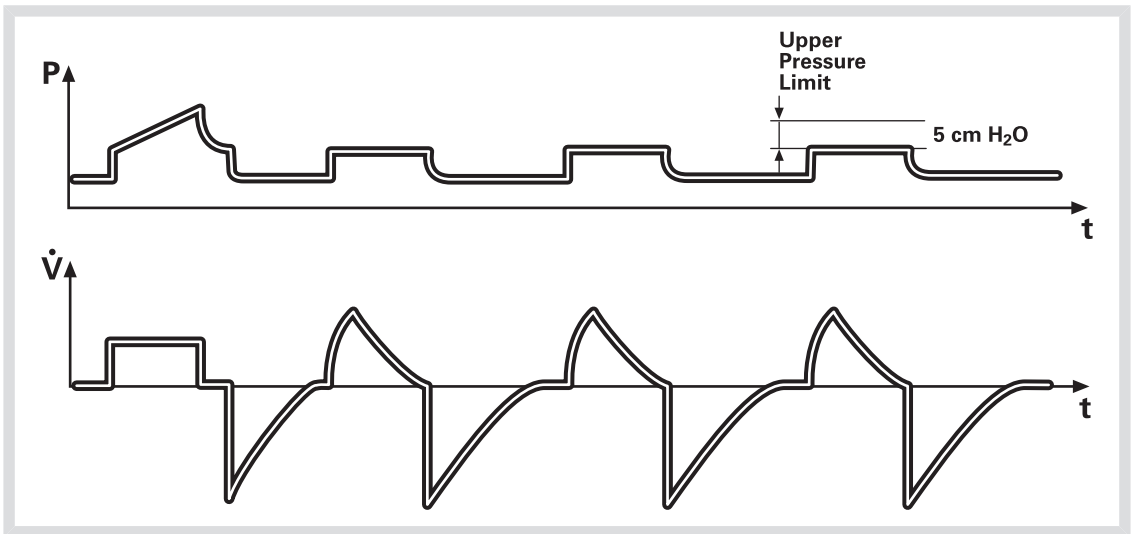

The first breath of a start sequence is a volume-controlled test breath with Pause time set to 10%. The measured pause pressure of this breath is then used as the pressure level for the following breath. An alarm is activated if the pressure level required to achieve the set target volume cannot be delivered due to a lower setting of the upper pressure limit (- 5 cmH₂O).

6.7 PRESSURE SUPPORT

6.7.1 FUNCTIONAL DESCRIPTION PRESSURE SUPPORT

Pressure Support is a patient initiated breathing mode in which the ventilator supports the patient with a set constant pressure.

Inspiration is supported by a constant preset pressure when activated by patient effort. The patient determines frequency and duration of the breaths, which show a decelerating flow pattern. Inspiratory breath duration can be influenced by adjusting the Inspiratory cycle-off criteria.

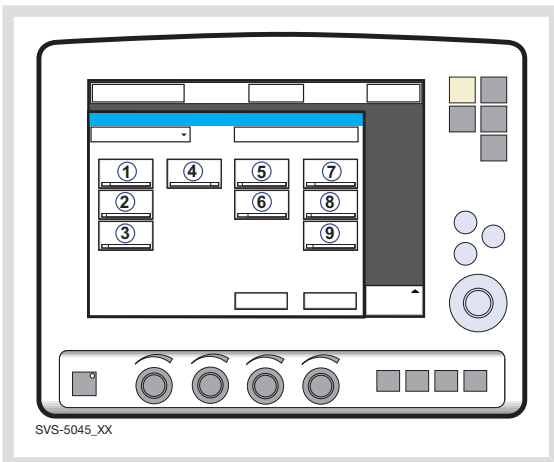

The following parameters are set:

1. PS (Pressure Support level) above PEEP (cmH₂O)
2. PEEP (cmH₂O)
3. Oxygen concentration (%)
4. Inspiratory rise time (s)
5. Trigg. Flow / Trigg. Pressure
6. Inspiratory Cycle-off (%)

7. PC above PEEP (cmH₂O) in backup ventilation
8. Resp. Rate (b/min) in backup ventilation.
9. I:E / Ti (s) in backup ventilation (depending on configuration).

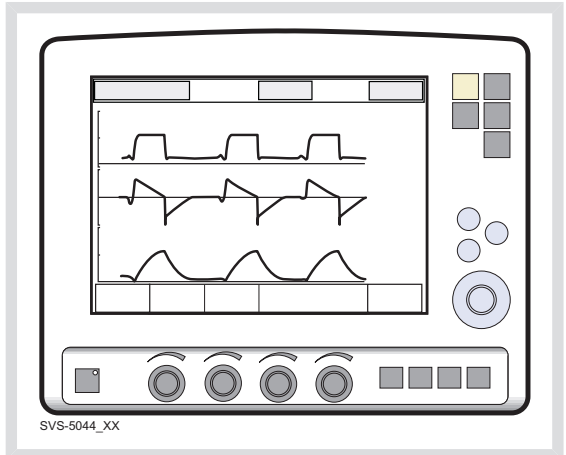

During Pressure Supported ventilation the patient regulates the respiratory rate and the Tidal Volume with support from the ventilator. The higher the pre-set inspiratory pressure level from the ventilator the more gas flows into the patient. As the patient becomes more active the pressure support level may be gradually reduced.

Always set the Apnea time appropriate to the individual patient situation. If the apnea alarm limit is reached the ventilator will automatically switch to backup ventilation.

Note: It is important to monitor the corresponding Tidal Volume levels.

It is also very important to set lower and upper alarm limit for expired Minute Volume.

It is important to set the Inspiratory rise time to a comfortable value for the patient. In Pressure Support the Inspiratory rise time should normally be increased.

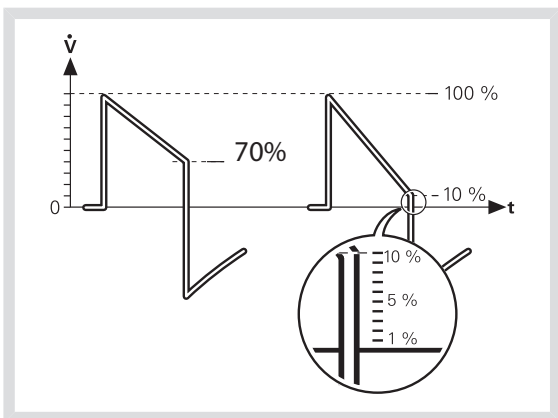

Inspiratory Cycle-off is important for the patient's comfort and ventilator synchronization with the patient. Inspiratory Cycle-off is the point when inspiration switches to expiration. E.g. for a patient with expiratory resistance the inspiratory Cycle-off should be set to a high value to guarantee enough time for expiration.

6.7.2 PRESSURE SUPPORT IN DETAIL

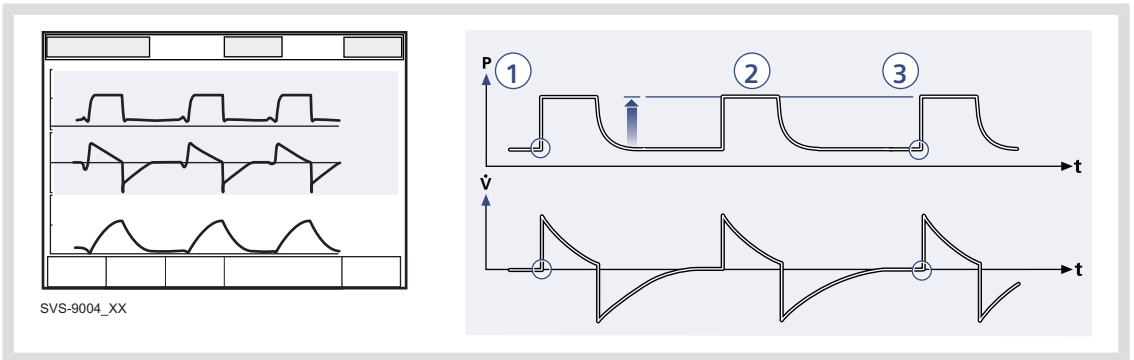

1. Pressure Support assures that a preset inspiratory pressure level is constantly maintained upon patient effort.
 2. The preset pressure level is controlled by the ventilator, while the patient determines frequency and inspiration time.
 3. Inspiration starts when the patient triggers a breath, gas flows into the lungs at a constant pressure. Since the pressure provided by the ventilator is constant, the flow will decrease until the Inspiratory Cycle-off is reached.
- Expiration starts:**
- a. When the inspiratory flow decreases below a preset fraction of the inspiratory peak flow (Inspiratory cycle-off)
 - b. If the upper pressure limit is exceeded.
 - c. If the maximum time for inspiration is exceeded.
 - d. If the flow drops to a flow range between 25% of the peak flow and lower limit for Inspiratory Cycle-off fraction level and the spent time within this range exceeds 50% of the time spent in between the start of the inspiration and entering this range.

6.8 SPONTANEOUS/CPAP

6.8.1 FUNCTIONAL DESCRIPTION SPONTANEOUS BREATHING/CPAP

True spontaneous breathing (CPAP) occurs when the inspiratory pressure level is set to zero in Pressure Support.

The mode Continuous Positive Airway Pressure is used when the patient is breathing spontaneously.

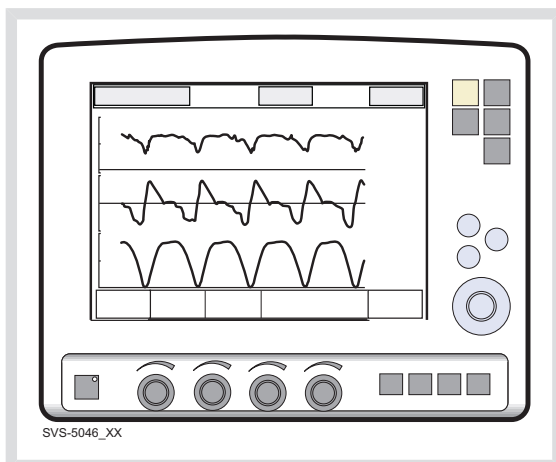

A continuous positive pressure is maintained in the airways. Properly set this may prevent collapse of airways. Inspiration starts upon patient effort. Expiration starts as for Pressure Support above.

Always set the Apnea time appropriately to the individual patient situation. If the apnea alarm limit is reached the ventilator will automatically switch to backup ventilation.

The alarm should alert staff to take action, either to go back to supported mode or change to a controlled mode of ventilation.

It is also very important to set lower and upper alarm limit for expired Minute Volume

For maximum inspiration time, see section Functions in ventilation modes on page 154.

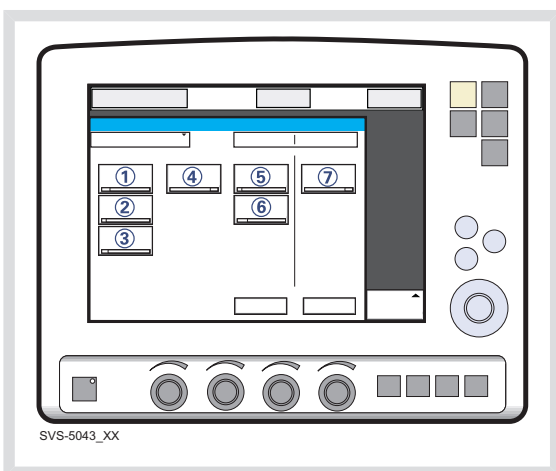

The following parameters are set:

1. PS (Pressure Support level) above PEEP (cmH₂O)
2. PEEP (cmH₂O)
3. Oxygen concentration (%)
4. Inspiratory rise time (s)
5. Trigg. Flow / Trigg. Pressure
6. Inspiratory Cycle-off (%)
7. PC (pressure control level) above PEEP (cmH₂O).

6.8.2 SPONTANEOUS BREATHING/CPAP IN DETAIL

True spontaneous breathing will occur:

- In Pressure Support when the inspiratory pressure level is set to zero

Inspiration starts upon patient effort.

Expiration starts:

- When the inspiratory flow decreases below a preset fraction of the inspiratory peak flow (Inspiratory cycle-off)
- If the upper pressure limit is exceeded.
- Maximum time for inspiration is exceeded.

6.9 SIMV

6.9.1 FUNCTIONAL DESCRIPTION SIMV

SIMV is a combination mode where the patient receives mandatory breaths synchronized with his breathing efforts and according to the selected SIMV mode. The patient can breathe spontaneously with Pressure Support in between the mandatory breaths.

There are three different SIMV modes, depending on the modes installed:

- SIMV (Volume Control) + Pressure Support
- SIMV (Pressure Control) + Pressure Support
- SIMV (PRVC) + Pressure Support

The mandatory breath is defined by the basic settings (as shown in the table below): Minute Volume/Tidal Volume (depending on configuration), PC above PEEP, I:E ratio/Inspiration time (depending on configuration), Pause time, Inspiratory rise time and Breath cycle time.

Note: In the Minute Volume configuration the Tidal Volume is determined by Minute Volume divided by SIMV rate.

The Breath cycle time is the length of the mandatory breath in seconds.

For example: A SIMV rate of 6, a breath cycle time of 3 seconds with an I:E ratio of 1:2 means that the inspiration will take 1 second and the expiration 2 seconds.

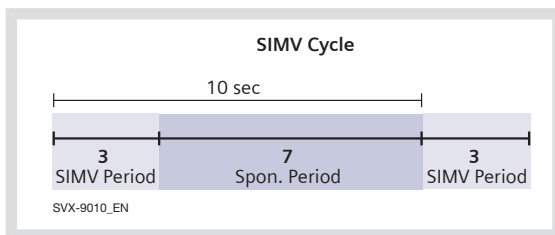

During the SIMV period, the first triggered breath will be a mandatory breath. If the patient has not triggered a breath within the first 90% of the Breath Cycle time a mandatory breath will be delivered.

Note: If the ventilator is configured for setting of Inspiration time, an I:E ratio of 1:2 will be used to estimate the Breath cycle time.

The spontaneous/pressure supported breaths are defined by setting the Pressure support level above PEEP.

6.9.2 THE MANDATORY BREATH

	SIMV (VC)+ PS	SIMV (PC) + PS	SIMV (PRVC)+PS
PC above PEEP		X	
Tidal volume /Minute volume	X		X
SIMV rate	X	X	X
Breath cycle time	X ¹	X ¹	X ¹
I:E ratio / Inspiration time	X	X	X
Insp. rise time	X	X	X
Pause time	X		

¹ Only when the ventilator is configured for I:E ratio setting.

6.9.3 SIMV (VOLUME CONTROL) + PRESSURE SUPPORT

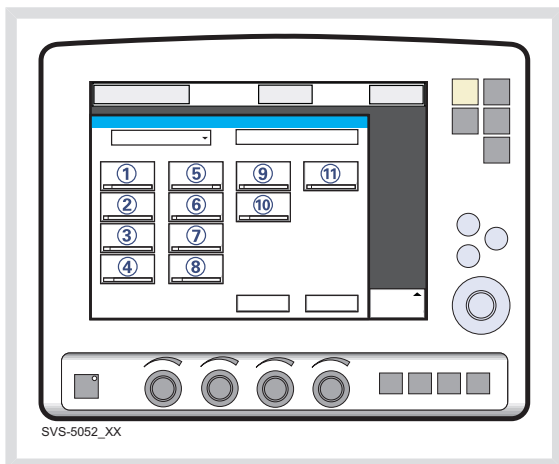

11. PS (Pressure support) above PEEP (cmH₂O)

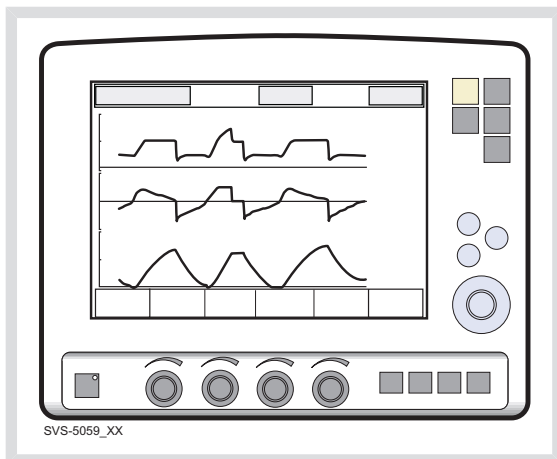

The following parameters are set:

1. Tidal Volume (ml)/Minute Volume (l/min)
2. SIMV rate (b/min)
3. PEEP (cmH₂O)
4. Oxygen concentration (%)
5. I:E ratio / Insp. time
6. Pause time (%/s)
7. Inspiratory rise time (%/s)
8. Breath cycle time (s)

Note: The touchpad Breath cycle time is not shown when an SIMV mode is selected and the ventilator is configured for inspiration time.

9. Trigg. Flow / Trigg. Pressure
10. Inspiratory Cycle-off (%)

6.9.4 SIMV - IN DETAIL

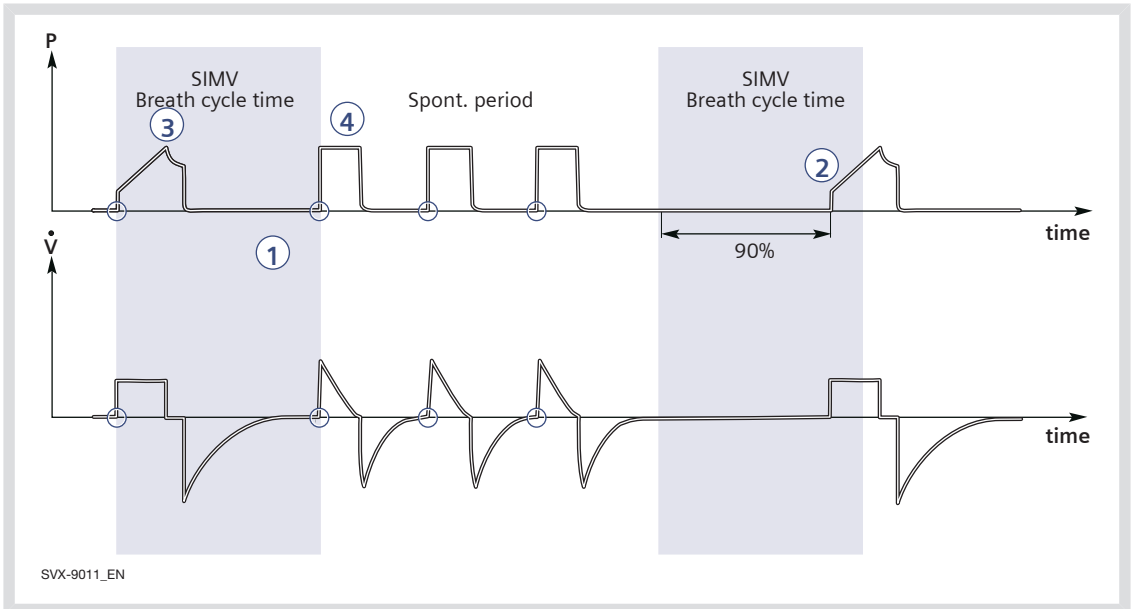

1. This combined control and pressure support/spontaneous function allows for preset mandatory breaths synchronized with the patient's breathing.
2. If there is no trigger attempt within a time window equal to 90% of the set Breath cycle time, a mandatory breath is delivered. (The Breath cycle time is the total time for one mandatory breath.)
3. The mandatory breath is defined by the basic settings (mode of ventilation, breath cycle time, respiratory pattern and volumes/pressures).
4. The spontaneous/pressure supported breaths are defined by the setting for Pressure Support.

SIMV (VC) + PS WITH ALTERNATIVE FLOW PATTERNS

When the *Volume Control with alternative flow patterns* is **enabled** in the start-up configuration, new touchpads for setting of alternative flow patterns are available in Volume Control, Automode VC <--> VS and SIMV (VC)+PS.

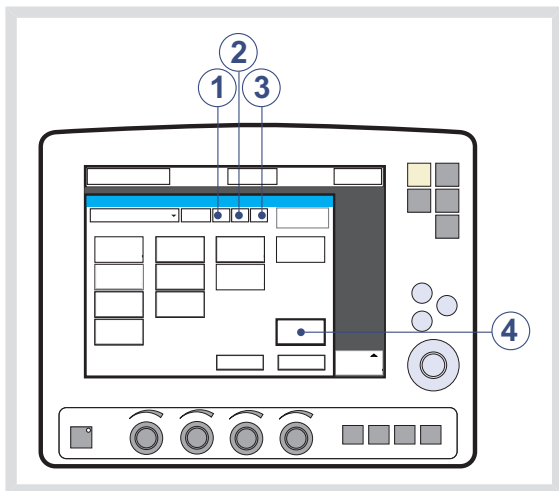

1. Volume control with flow adaptation
2. Volume control without flow adaptation
3. Volume control with decelerating flow
4. Flow pattern

See section Volume control with alternative flow patterns on page 81 for more information.

6.9.5 SIMV (PRESSURE CONTROL) + PRESSURE SUPPORT

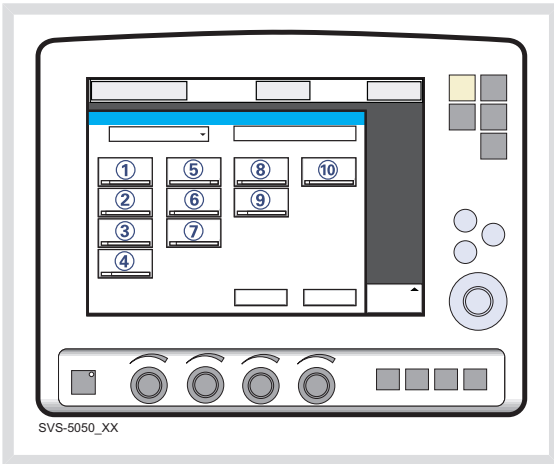

10. PS (Pressure Support level) above PEEP (cmH₂O)

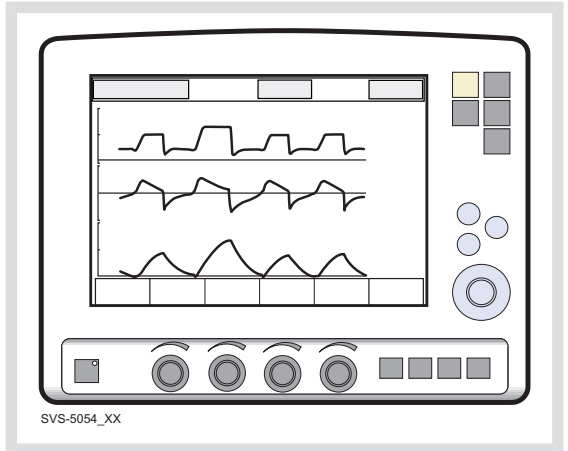

The following parameters are set:

1. PC (Pressure Control level) above PEEP (cmH₂O)
2. SIMV rate (b/min)
3. PEEP (cmH₂O)
4. Oxygen concentration (%)
5. I:E ratio / Insp. time
6. Inspiratory rise time (%/s)
7. Breath cycle time (s)

Note: The touchpad Breath cycle time is not shown when an SIMV mode is selected and the ventilator is configured for inspiration time.

8. Trigg. Flow / Trigg. Pressure
9. Inspiratory Cycle-off (%)

6.9.6 SIMV - IN DETAIL

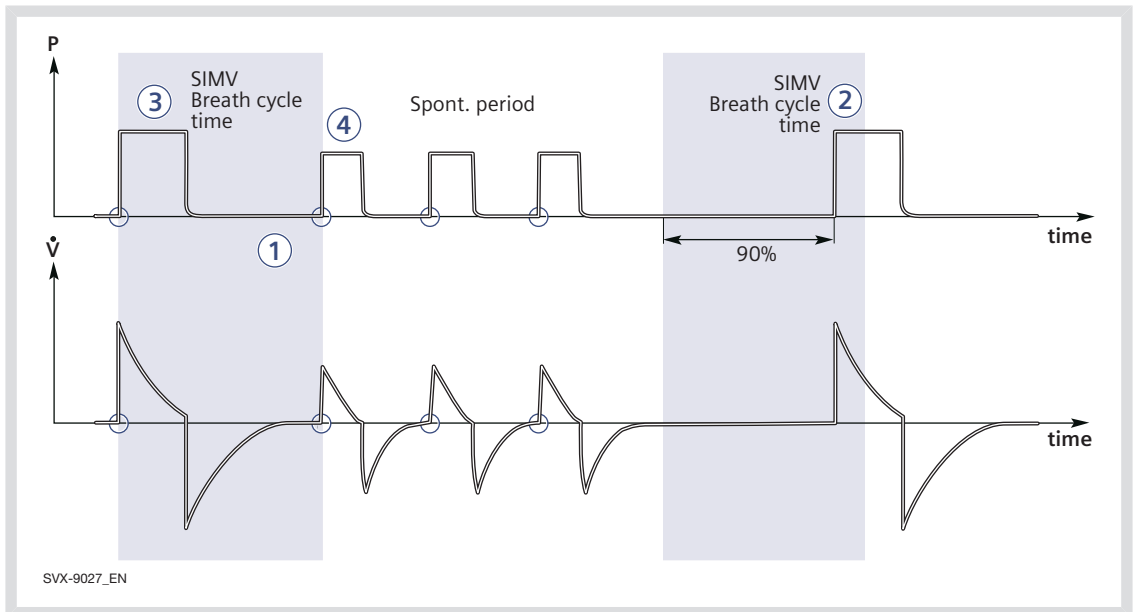

1. This combined control and pressure support/spontaneous function allows for preset mandatory breaths synchronized with the patient's breathing.
2. If there is no trigger attempt within a time window equal to 90% of the set Breath cycle time, a mandatory breath is delivered. (The Breath cycle time is the total time for one mandatory breath.)
3. The mandatory breath is defined by the basic settings (mode of ventilation, breath cycle time, respiratory pattern and volumes/pressures).
4. The spontaneous/pressure supported breaths are defined by the setting for Pressure Support.

6.9.7 SIMV (PRVC) + PRESSURE SUPPORT

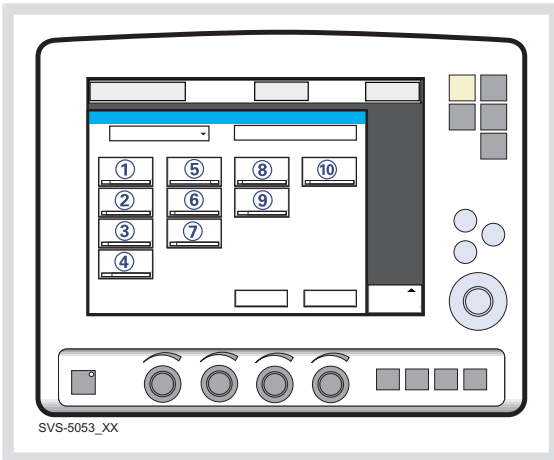

The following parameters are set:

1. Tidal Volume (ml)/Minute Volume (l/min)
2. SIMV rate (b/min)
3. PEEP (cmH₂O)
4. Oxygen concentration (%)
5. I:E ratio / Insp. time
6. Inspiratory rise time (%/s)
7. Breath cycle time (s)

Note: The touchpad Breath cycle time is not shown when an SIMV mode is selected and the ventilator is configured for inspiration time.

8. Trigg. Flow / Trigg. Pressure
9. Inspiratory Cycle-off (%)

10. PS (Pressure Support level) above PEEP (cmH₂O)

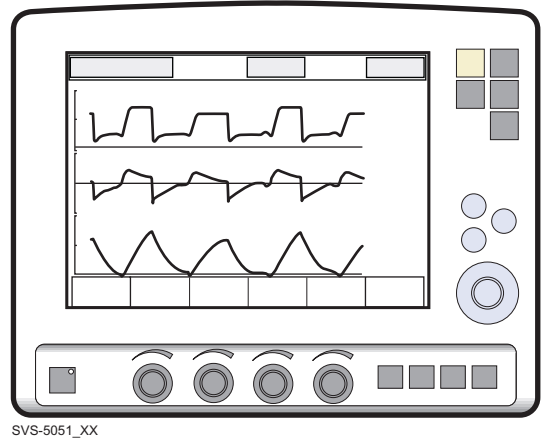

6.9.8 SIMV - IN DETAIL

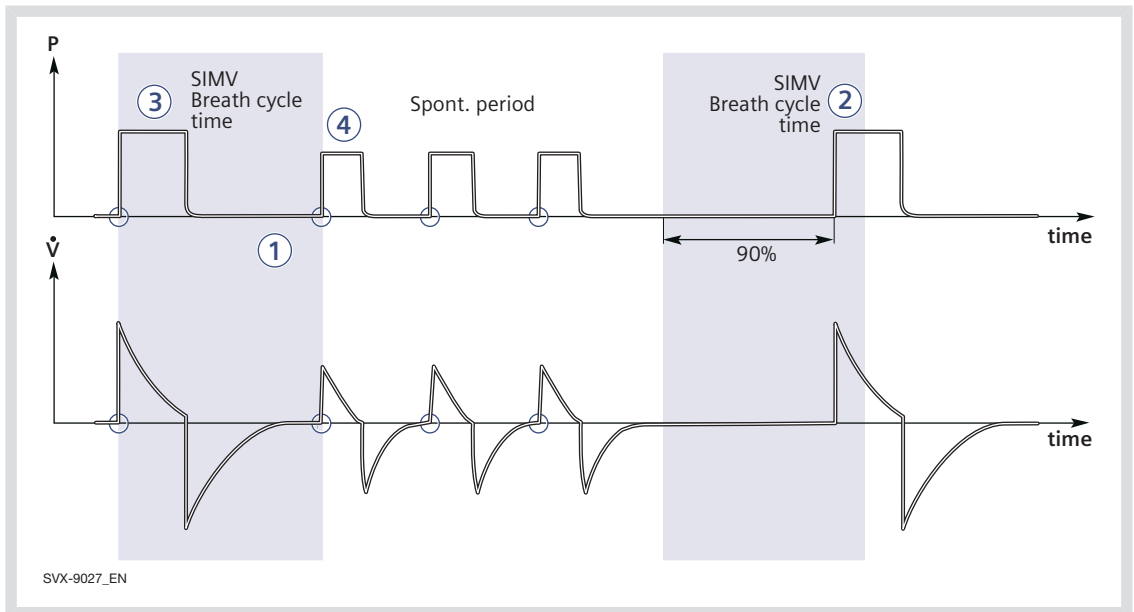

1. This combined control and pressure support/spontaneous function allows for preset mandatory breaths synchronized with the patient's breathing.
2. If there is no trigger attempt within a time window equal to 90% of the set Breath cycle time, a mandatory breath is delivered. (The Breath cycle time is the total time for one mandatory breath.)
3. The mandatory breath is defined by the basic settings (mode of ventilation, breath cycle time, respiratory pattern and volumes/pressures).
4. The spontaneous/pressure supported breaths are defined by the setting for Pressure Support.

6.10 BI-VENT

6.10.1 FUNCTIONAL DESCRIPTION

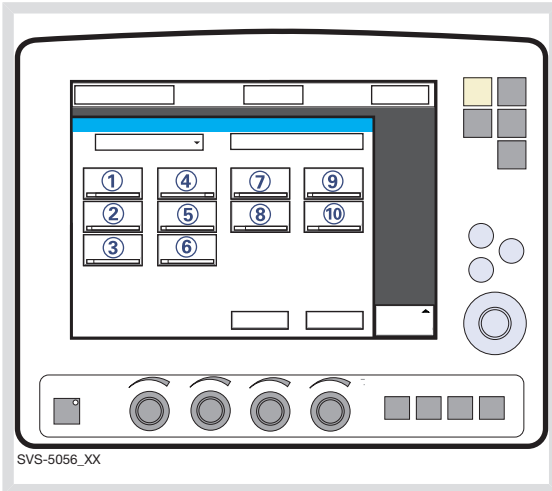

Bi-Vent is pressure controlled breathing that allows the patient the opportunity of unrestricted spontaneous breathing. Two pressure levels are set together with the individually set duration of each level. Spontaneous breathing efforts can be assisted by pressure support

The following parameters are set:

1. Pressure high (PHigh) for the higher pressure level (cmH₂O)
2. PEEP for the lower pressure level (cmH₂O)
3. Oxygen concentration (%)
4. Time at the higher pressure (THigh) level (s)
5. Time at the lower pressure (TPEEP) level (s)
6. Inspiratory rise time (s)
7. Trigg. Flow / Trigg. Pressure
8. Inspiratory Cycle-off (%)
9. PS (Pressure Support level) above PHigh (cmH₂O)
10. PS (Pressure Support level) above PEEP (cmH₂O)

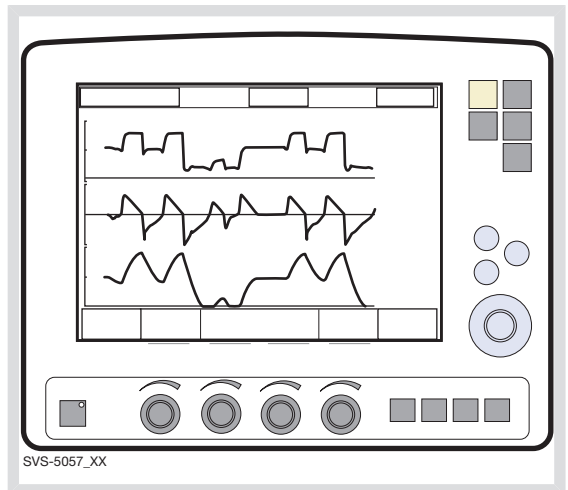

In the Bi-Vent mode the ventilator uses two shifting pressure levels, with the patient being able to breathe spontaneously on both these levels.

Since Bi-Vent is basically a controlled mode of ventilation, apnea alarm and backup ventilation are not available. It is also very important to set lower and upper alarm limit for expired Minute Volume.

Every Bi-Vent cycle is regarded as autonomous and therefore most of the measured values are updated every Bi-Vent cycle, i.e. minute volumes, respiratory rate, mean pressure and end expiratory pressure. In accordance to this, associated alarms are also handled for every Bi-Vent cycle.

At extreme settings the update of measured values and alarms will show a mandatory frequency dependence even in the face of preserved spontaneous breathing.

As a result of switching between two different pressure levels, the tidal volumes may vary significantly between different breaths. This may also be the case for etCO₂ concentration.

It is not recommended to use Auto scale in Bi-Vent mode, when the patient is breathing spontaneously on both levels.

6.10.2 BI-VENT IN DETAIL

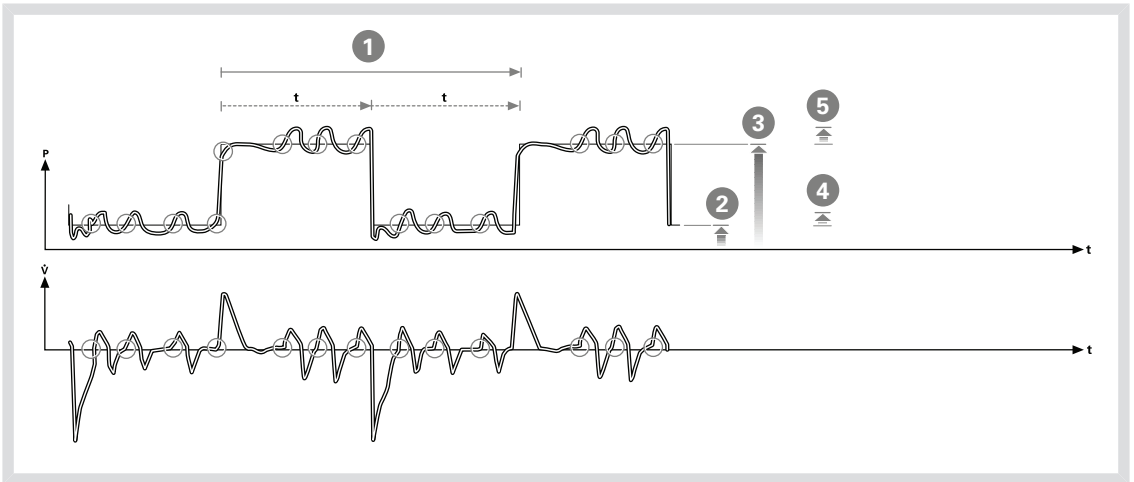

This function allows for spontaneous breathing / pressure supported ventilation at two different pressure levels. These basic levels are individually set, as well as the time in seconds at each level. The ventilator always tries to synchronize with the patient's breathing.

1. Bi-Vent cycle; THigh + TPEEP
2. PEEP
3. PHigh
4. PS above PEEP
5. PS above PHigh

6.11 NON INVASIVE VENTILATION

6.11.1 NON INVASIVE VENTILATION

This chapter refers to when the SERVO-s Ventilator System is used during Non Invasive Ventilation (NIV). NIV refers to ventilation, where the patient is not intubated or tracheotomized. It is achieved using a nasal mask, face mask or full-face mask.

Note: In NIV, flow and pressure curves and the measured values: VT_i, VT_e, MV_e, MVI are compensated for leakage.

The NIV disconnect function is available in all NIV modes and can be set via the Biomed>Edit startup configuration window.

The setting can be used to ensure a constant disconnect flow while ventilation is paused (High flow and Low flow) or as a way to avoid pausing ventilation in case of high leakage (Disabled).

For NIV disconnect function settings, see Functions in ventilation modes on page 154.

WARNINGS!

- Avoid high inspiratory pressure as it may lead to gastric overdistension and risk of aspiration. It may also cause excessive leakage.
- The dead space will increase when a mask is used.
- NIV is not intended to be used on intubated patients.
- CO₂ measurement will be affected by mask leakage.
- In non-invasive ventilation, the measured expired volume may be different from the actual volume exhaled by the patient due to leakage around the mask.

CAUTIONS:

- It is not recommended to use a nebulizer during NIV as the nebulized drug might come in contact with the patient eyes in case of leakage.
- Mask leakage might affect the efficiency of a nebulizer.

Important:

- The mask must be applied correctly in order to avoid leakage.
- Selection of a mask must take into consideration its proper size and accurate adaptation to the patient.
- CO₂ rebreathing will increase during NIV and use of a face mask.

Read about alarm settings on page 126.

See also *Set Ventilation Mode* on page 52.

6.11.2 FUNCTIONAL DESCRIPTION PRESSURE CONTROL

The NIV Pressure Controlled mode is a controlled breathing mode.

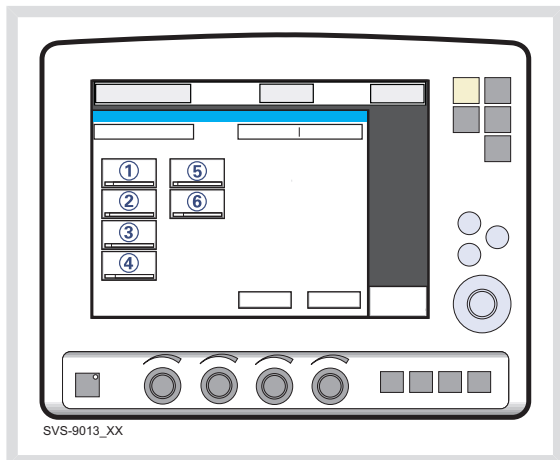

The following parameters are set:

1. PC (Pressure Control level) above PEEP (cmH₂O)
2. Respiratory Rate (b/min)
3. PEEP (cmH₂O)
4. Oxygen concentration (%)
5. I:E ratio / Insp. time
6. Inspiratory rise time (%/s)

Differences from invasive Pressure control mode:

- When the Standby key is pressed a waiting position dialog is shown. All patient related alarms are turned off during 120 seconds. Press the Start ventilation touchpad to start the ventilation.
- During NIV the ventilator automatically adapts to variations in leakage in order to maintain the required pressure and PEEP level. If leakage is excessive, the ventilator will issue a high priority alarm and deliver a flow according to settings. Ventilation will resume automatically if the leakage decreases. Ventilation can also be started manually by pressing the *Resume ventilation* touchpad in the dialog.
- Trigger sensitivity cannot be set in NIV.
- Detection of pressure below PEEP or expiratory volume decrease will start a new breath.

Read about alarm settings on page 126.

See also *Set Ventilation Mode* on page 52.

6.11.3 FUNCTIONAL DESCRIPTION PRESSURE SUPPORT

NIV PS is a patient initiated breathing mode in which the ventilator supports the patient with a set constant pressure.

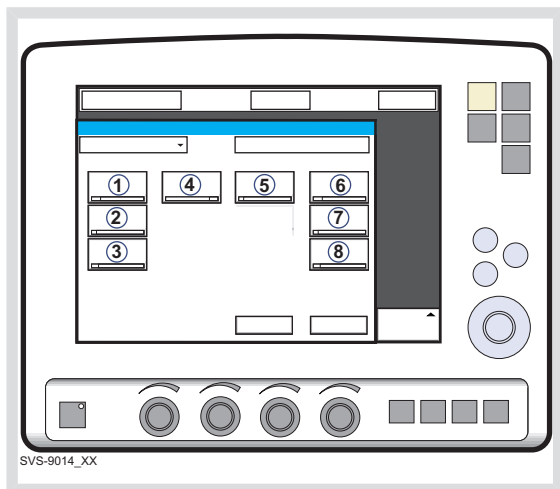

The following parameters are set:

1. PS (Pressure Support level) above PEEP (cmH₂O)
2. PEEP (cmH₂O)
3. Oxygen concentration (%)
4. Inspiratory rise time (s)
5. Inspiratory Cycle-off (%)
6. PC above PEEP (cmH₂O) in backup ventilation
7. Resp.Rate (b/min) in backup ventilation.
8. I:E / Ti (s) in backup ventilation (depending on configuration).

Differences from invasive Pressure support mode:

- When the Standby key is pressed a waiting position dialog is shown. All patient related alarms are turned off during 120 seconds. Press the Start ventilation touchpad to start the ventilation.
- During NIV the ventilator automatically adapts to variations in leakage in order to maintain the required pressure and PEEP level. If leakage is excessive, the ventilator will issue a high priority alarm and deliver a flow according to settings. Ventilation will resume automatically if the leakage decreases. Ventilation can also be started manually by pressing the *Resume ventilation* touchpad in the dialog.
- The ventilator will not lock in backup ventilation. There is no limit on the number of times the ventilator can switch between supported mode and backup.
- Trigger sensitivity cannot be set in NIV.

Read about alarm settings on page 126.

See also *Set Ventilation Mode* on page 52.

6.12 BACKUP VENTILATION

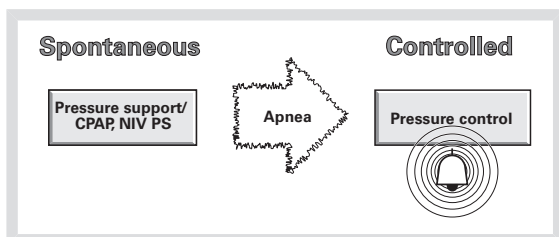

Backup ventilation is available in all support modes.

For apnea alarm setting range, see section Alarm limits on page 153.

The minimum backup pressure level is 5 cmH₂O.

See the tabulated breathing parameter settings on page 151.

6.12.1 FUNCTIONAL DESCRIPTION

Backup ventilation switches Pressure Support and CPAP to Pressure Control.

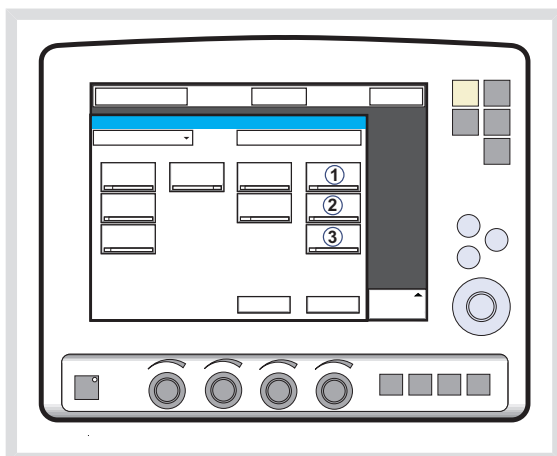

The following parameters are set:

1. PC above PEEP (cmH₂O) in backup ventilation, Pressure Support
2. Resp.Rate (b/min) in backup ventilation.
3. I:E / Ti (s) in backup ventilation (depending on configuration).

NO PATIENT EFFORT

In case of apnea, the ventilator will switch to backup ventilation according to the backup settings at the end of the set apnea time.

The *Apnea time* is set in the *Alarm Profile* window.

Backup is indicated in the active *Ventilation mode* touchpad and the alarm *No patient effort* is displayed on the screen.

If the patient triggers a breath, the ventilator automatically switches back to the supported mode.

NO CONSISTENT PATIENT EFFORT

No consistent patient effort is an alarm in invasive ventilation.

If the patient fulfils the criteria for the *No consistent patient effort* alarm, the ventilator will lock in backup ventilation.

A dialog *You are in Backup ventilation. Review ventilation settings or continue in support mode* is displayed on the screen. As long as this dialog is open no other menu window or dialog can be accessed. Only the Standby touchpad is active.

The user will be given the following choices:

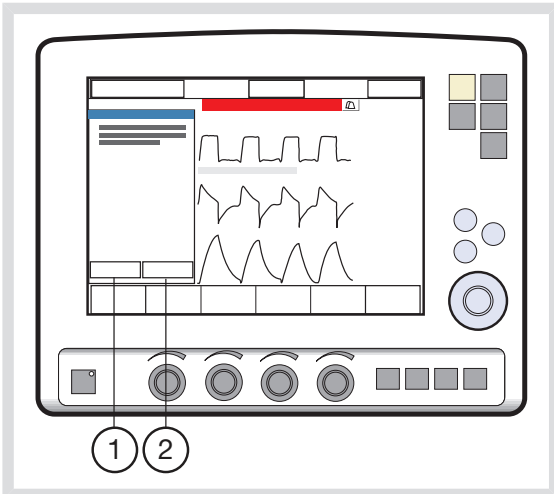

1. Review vent. settings
2. Continue in support mode

The ventilator will remain in backup ventilation until a choice is made.

REVIEW VENTILATION SETTINGS

Press *Review vent. settings* in the *Backup ventilation* window to return to the *Set Ventilation Mode* window.

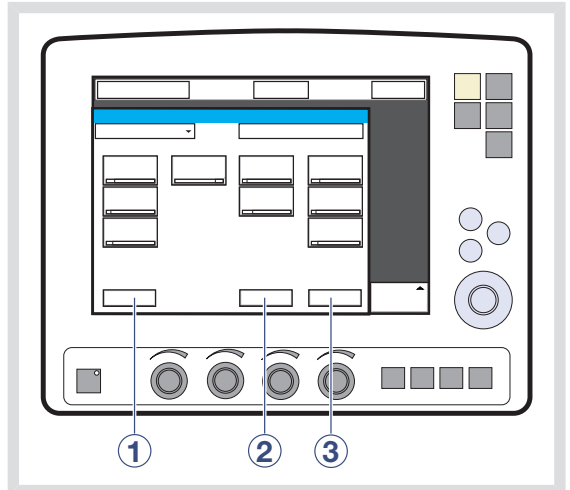

The following functions are available:

1. *Previous Mode* - recalls the previous accepted ventilation mode.
2. *Cancel* - closes the *Set Ventilation Mode* window without changes being applied, i.e. ventilation will continue as before.
3. *Accept* - accepts the settings and continues in the supported mode with reset apnea time.

CONTINUE IN SUPPORT MODE

Press *Continue in support mode* in the *Backup ventilation* window to continue in support mode. The apnea time will be reset.

6.12.2 DISABLING BACKUP VENTILATION

The backup ventilation can only be disabled in invasive ventilation.

It is possible to either enable or disable Backup ventilation via the *Biomed* menu. If this choice is made, then an extra touchpad (*Backup ventilation*) (1), is displayed in the *Set Ventilation Mode* window during ventilation.

Note: It is only possible to deactivate backup ventilation when running, not in Standby.

To disable backup ventilation:

1. Press the *Backup ventilation* touchpad.
2. A confirmation dialog *Do you really want to deactivate backup ventilation?* is displayed. Confirm by pressing Yes.
3. *Backup ventilation off* is displayed on the *Ventilation mode* touchpad.
4. Press *Accept* in the *Set Ventilation Mode* window.

The backup function is automatically re-activated if the user:

- Changes to a controlled mode of ventilation.
- Sets the ventilator to Standby.
- Turns off the system.

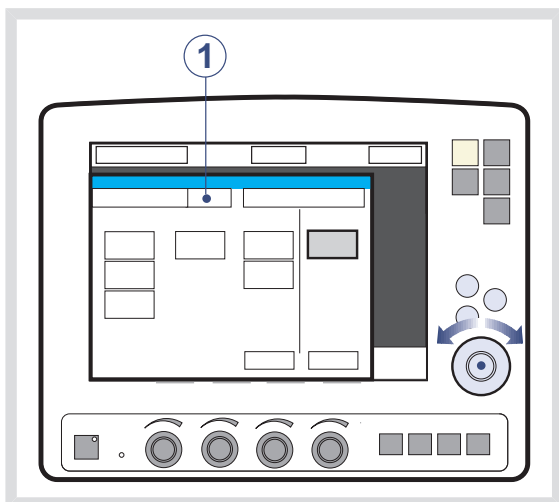

6.13 VENTILATORY PARAMETERS - OVERVIEW

When a ventilation mode is selected, the only parameters shown are those affecting the actual mode. Below are all the mode-related parameters presented.

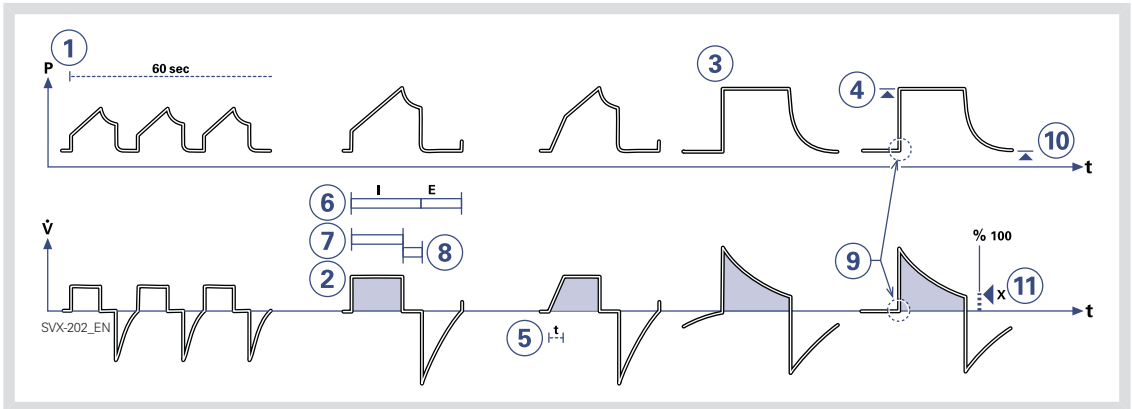

1. Respiratory rate (RR) Rate of controlled mandatory breaths or used for calculation of target volume (b/min).
2. Tidal volume (VT) Volume per breath or target volume (ml).
Minute volume (MV) Volume per minute or target Minute volume (ml/min or l/min). Presentation can be configured to either tidal or minute volume.
3. PC above PEEP Inspiratory pressure level for each breath (cmH₂O) in Pressure Control.
4. PS above PEEP Inspiratory pressure support level for triggered breaths (cmH₂O) in Pressure Support.
5. Inspiratory rise time (T_{insp. rise}) Time to full inspiratory flow or pressure at the start of each breath, as a percentage of the breath cycle time (%), or in seconds (s).
6. I:E ratio (I:E) (Inspiration time + Pause time): Expiration time.
7. Inspiration time (Ti) Time for active flow or pressure delivery to the patient (s).
8. Pause time (T_{pause}) Time for no flow or pressure delivery (% or s).
9. Trigger sensitivity
 - a. Below zero: Trigger sensitivity is pressure dependant. The pressure below PEEP which the patient must create to initiate an inspiration (cmH₂O) is indicated.
 - b. Above zero: Trigger sensitivity is flow dependent. As the dial is advanced to the right (step wise from the green into the red area) the trigger sensitivity increases i.e the inhaled fraction of the bias flow leading to triggering is reduced.
10. PEEP Positive End Expiratory Pressure (cmH₂O).
11. Inspiratory cycle-off Fraction of maximum flow at which inspiration should switch to expiration (%).

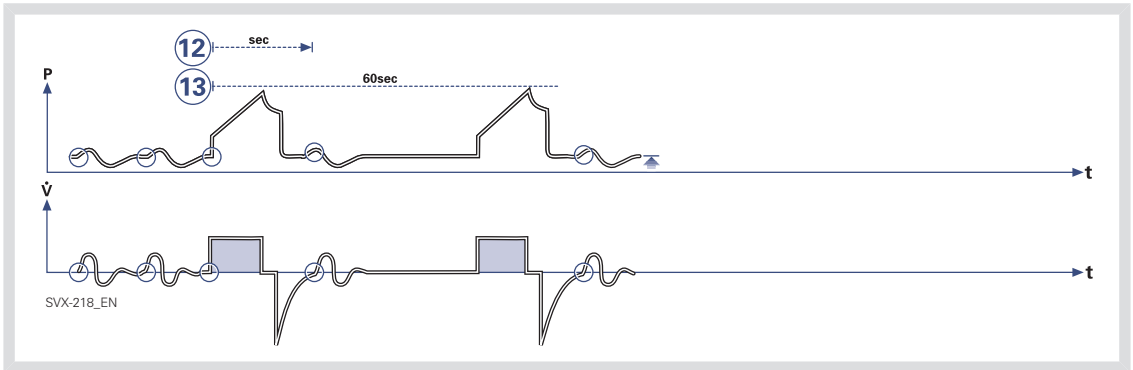

12. Breath cycle time (Breath cycle T) Total cycle time per mandatory breath in SIMV (inspiratory + pause + expiratory). Set in seconds.

13. SIMV rate Rate of controlled mandatory breaths (b/min).

O₂ concentration (O₂ Conc.) O₂ concentration in inspiratory gas (not shown in the figure).

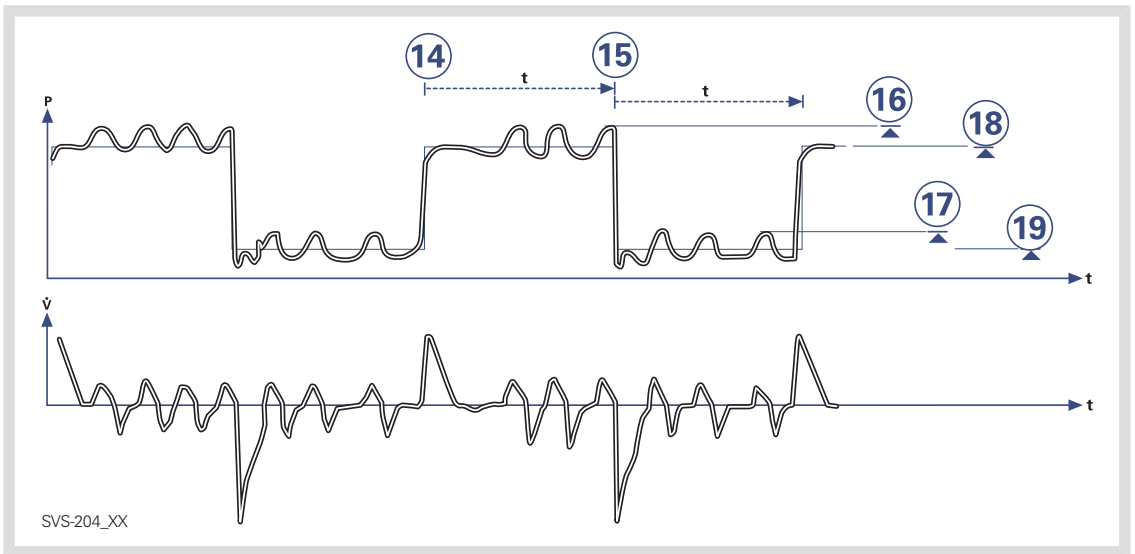

14. Time high (THigh) Time at PHigh level in Bi-Vent (s).
15. Time PEEP (TPEEP) Time at PEEP level in Bi-Vent (s).
16. Pressure Support above Pressure high (PS above PHigh) Inspiratory pressure support level for breaths triggered during the THigh period in Bi-Vent (cmH_2O).
17. Pressure Support above PEEP (PS above PEEP) Inspiratory pressure support level for breaths triggered during the TPEEP period in Bi-Vent (cmH_2O).
18. Pressure high (PHigh) Positive End Expiratory Pressure at the upper level in Bi-Vent (cmH_2O).
19. PEEP Positive End Expiratory Pressure at the lower level in Bi-Vent (cmH_2O).

6.14 SPECIAL FUNCTIONS

6.14.1 FIXED KEYS

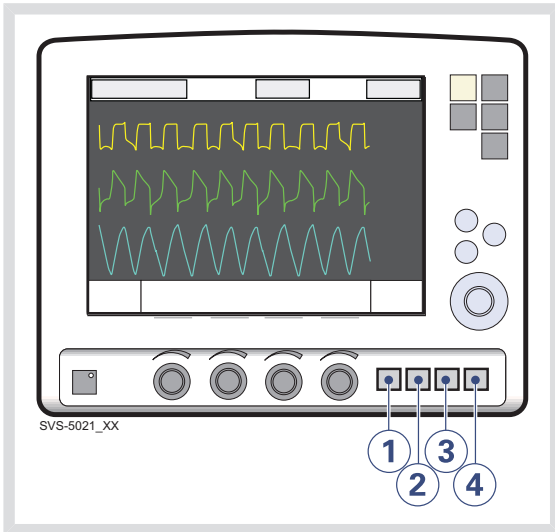

1. Start breath
2. O₂ breaths
3. Expiratory hold
4. Inspiratory hold

Can all be chosen by manually pressing the respective fixed key.

START BREATH

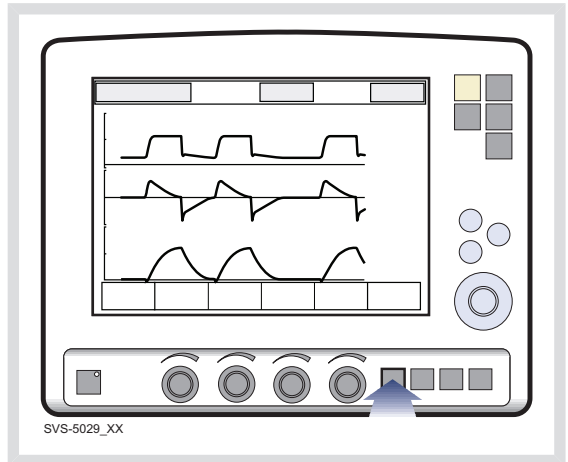

The ventilator will initiate a new breath cycle according to the current ventilator settings.

O₂ BREATHS

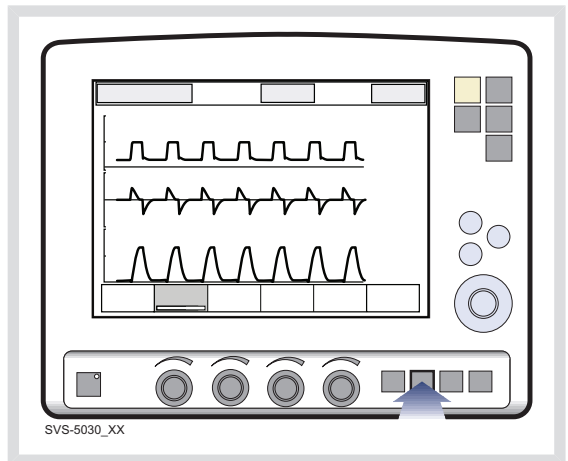

This function delivers 100% oxygen for 1 minute. After this time the oxygen concentration will return to the pre-set value. The oxygen breaths can be interrupted by repressing the O₂ breaths fixed key during the 1 minute interval.

EXPIRATORY HOLD

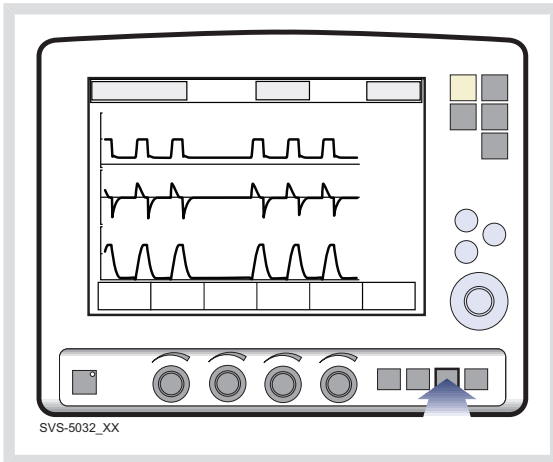

Expiratory and inspiratory valves are closed after the expiration phase is completed, for as long as the fixed key is depressed, up to a maximum of 30 seconds. Expiratory hold provides an exact measurement of the end expiratory pause pressure. It can be used to determine total PEEP and, together with inspiratory hold, static compliance. The dynamic pressure is shown on the PEEP numerical value.

INSPIRATORY HOLD

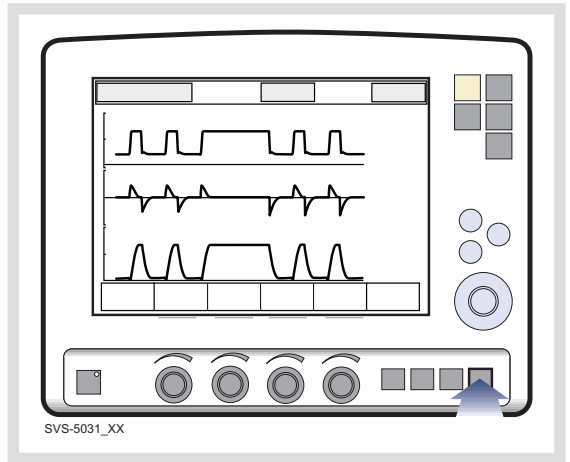

Inspiratory hold is activated by manually pressing the fixed key. The maximum time is 30 seconds. The inspiratory and expiratory valves close after inspiration. This function can provide an exact measurement of the end inspiratory lung pressure. It can be used during x-ray or to determine Plateau pressure, or, together with expiratory hold, calculate static compliance.

Read about alarm settings on page 126.

See also *Set Ventilation Mode* on page 52.

7 ALARMS

TABLE OF CONTENTS

7.1	Introduction	120
7.2	Handling Alarms	122
7.3	Alarm Settings for Breathing Parameters	126

7.1 INTRODUCTION

The SERVO-s Ventilator System is equipped with an alarm system to help ensure patient safety. Visual and audible alarms warn about:

- patient breathing problems e.g., apnea
- power problems e.g., loss of AC power
- problems with gases e.g., low supply pressure
- hardware problems e.g., overheating
- software problems e.g., memory failure

This chapter describes general responses to alarms, provides the procedure for setting alarm limits (see also the *Operation Overview* chapter), and lists breathing-related alarm settings along with their allowed ranges.

The *Power Supply* chapter describes power supply-related alarms.

The *System Messages* chapter lists all alarms along with possible causes and remedies.

WARNINGS!

- The default setting of the high airway pressure alarm is 40 cmH₂O. It is important to adjust this setting as appropriate to avoid excessive airway pressures.
- A potential hazard can arise if different default alarm settings are used on ventilators or similar equipment which are located within the same intensive care unit or cardiac operating theatres.

Important: Those responding to alarms must be health care professionals who have experience in ventilation treatment and who have been trained in the use of the SERVO-s Ventilator System.

7.1.1 ALARM OUTPUT CONNECTION OPTION

If your system is equipped with the alarm output connection option, high and medium priority alarms can be transferred to an external signal system. The alarm output signal is active as long as the audio alarm is active on the ventilator.

WARNING! Never leave the patient unattended; the external alarm is designed to alert those already in attendance.

CAUTION: The alarm output is a nonguaranteed alarm according to IEC 60601-1-8 and it is recommended that users establish a Pre-use check routine for this application.

7.1.2 VISUAL ALARM DISPLAY

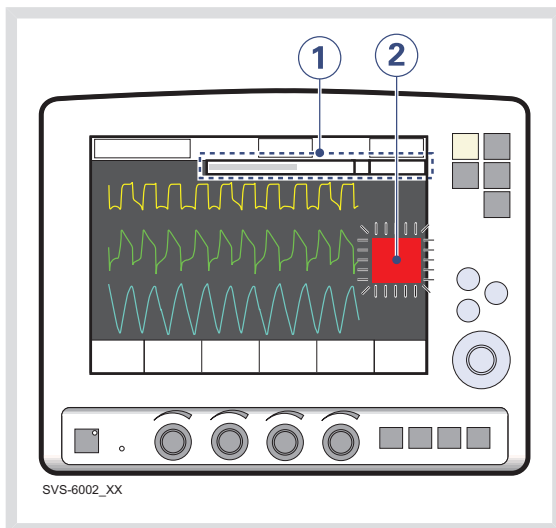

When an alarm is activated, the following information is supplied on the screen.

1. A text message explaining the cause of the alarm flashes in the alarm message area. The alarm with highest priority is displayed first.
2. The corresponding measured value or set value box flashes and an arrow points at the exceeded limit.

Note: Two bells in the alarm message area indicate that more than one alarm is activated.

7.2 HANDLING ALARMS

The system can signal four types of alarm:

- High Priority—red background
- Medium Priority—yellow background
- Low Priority—yellow background
- Technical—a numeric code

The following sections provide general information about viewing, responding to, silencing, and turning off alarms.

7.2.1 VIEWING THE CURRENT ALARMS WINDOW

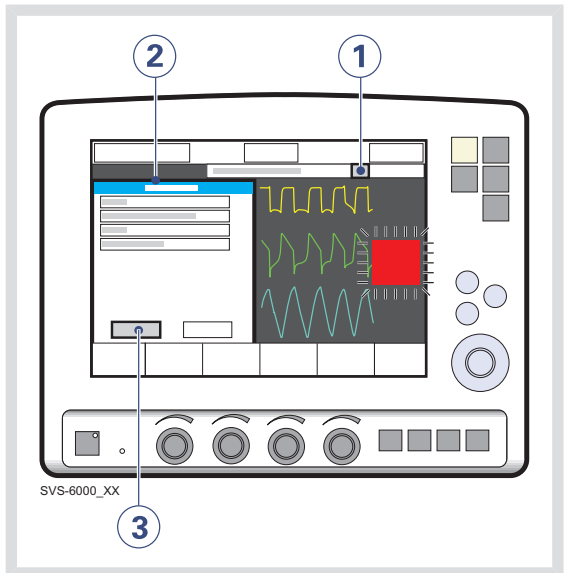

If more than one alarm is active, view the Current Alarms Window by:

1. Press the bell(s) in the alarm message touchpad.
All alarms (up to 10 listed by priority) are shown in a dynamic window that will be updated if more alarms occur while the window is open.
2. View the current alarms.
3. Press the History touchpad.
The previous 16 alarm-dependent events are listed chronologically, with the most recent event at the bottom.

Note: For viewing more than the latest 10 alarms, use the Event log to view all logged alarms.

7.2.2 RESPONDING TO ALARMS

To respond to a High or Medium priority alarm:

1. If desired, press the *Audio Pause* fixed key for less than two seconds to silence the alarm for two minutes.
2. Take action to resolve the alarm condition.
3. Press the *Audio Pause* key to reset the latched high priority alarm and clear the message from the screen.

The *Audio Pause* key is identified by the  symbol.

To respond to a Low priority alarm:

1. If desired, press the *Audio Pause* key for less than two seconds to reset the alarm even if the alarm condition remains.
2. Take action to resolve the alarm condition.

The alarm is automatically reset once the alarm condition ceases.

Note:

The following Medium Priority alarms display an *Audio off?* message when activated:

- *Air Supply Pressure: Low*
- *O₂ Supply Pressure: Low*
- *Battery Operation*

For these alarms, you can silence the audio signal even if the alarm condition is not resolved. However, the system will eventually reactivate the alarm.

Using the Audio Pause Key

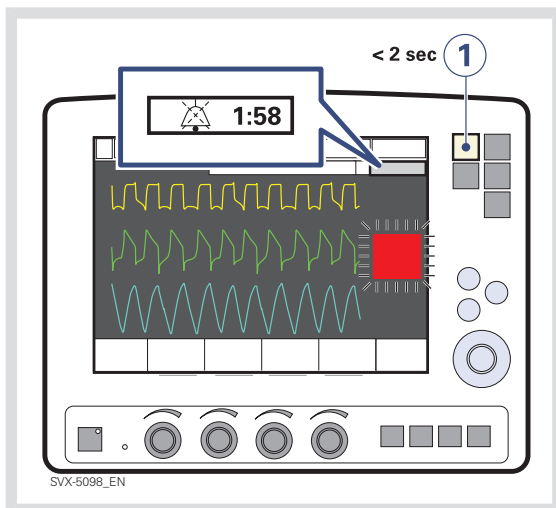

Pressing the *Audio Pause* fixed key for less than two seconds has the following results:

- Active alarms are silenced for two minutes.
- A crossed bell symbol along with the time remaining in the silent period are displayed in the message area.
- Each press of the *Audio Pause* key restarts the two minute silent period from when the user last pressed the key.
- Latched alarms are reset if the alarm condition has ceased.

Note: The *No battery capacity* alarm and technical alarms cannot be silenced.

7.2.3 PRE-SILENCING ALARMS

To silence most alarms (active and inactive) for two minutes, press and hold the *Audio Pause* fixed key for more than two seconds.

This action has the following results:

1. All alarms, active and inactive, are silenced for two minutes from the time the key was pressed.
2. A double crossed bell symbol along with the time remaining in the silent period are displayed in the message area.
3. Pressing the *Audio Pause* key again for less than two seconds will now restart the silent period for two additional minutes from when the user last pressed the key.
4. Latched alarms are reset if the alarm condition has ceased.

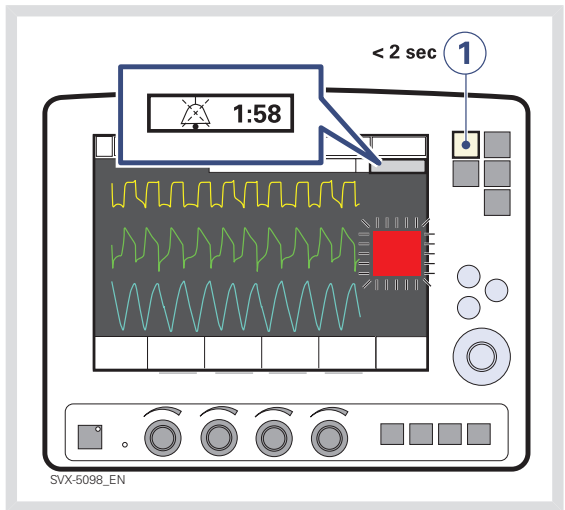

When the alarms are pre-silenced, pressing and holding the *Audio Pause* key again for more than 2 seconds will reactivate all audible alarms.

7.2.4 RESPONDING TO TECHNICAL ALARMS

In some cases, restarting the system may resolve a technical alarm. However, technical alarms often necessitate taking the ventilator out of operation and having it serviced. See the chapter System Messages, section Technical error messages on page 138 for further details.

7.2.5 RESETTING LATCHED ALARMS

High Priority alarms are “latched” – the alarm message remains on the screen even if the alarm condition ceases. Medium and Low Priority alarms are not latched. The fixed key *Audio Pause* resets latched alarms and clears the alarm message from the screen.

Note: The NIV alarm *Leakage out of range* is not latched.

7.2.6 PERMANENTLY SILENCING ALARMS

To permanently silence certain alarms in NIV mode:

1. Press the *Alarm Profile* fixed key.
2. Press the touchpad corresponding to one of the following alarms:
 - Minute Volume
 - Respiratory Rate
 - PEEP
3. Press the *bell-symbol* touchpad. The symbol changes to a crossed bell indicating audio is off.

Note: If the system is set in Standby and used in an invasive mode, the NIV alarms will return to their default states.

7.3 ALARM SETTINGS FOR BREATHING PARAMETERS

This section discusses viewing and setting alarm limits, lists alarm settings, explains the conditions under which alarm limits are set to their default values.

See section Alarm limits on page 153.

7.3.1 VIEWING ALARM LIMITS

Alarm limits may be viewed in the Measured Values Display on the right side of the screen. See the *Monitoring and Recording* chapter for details on the Measured Value Display.

7.3.2 SETTING ALARM LIMITS

To set alarm limits, touch the fixed key Alarm Profile in the upper right corner of the screen (see the *Operation Overview* chapter for details about setting limits).

7.3.3 CONDITIONS LEADING TO DEFAULT ALARM SETTINGS

Alarm limits become set to their default values when:

- restarting the ventilator
- admitting a new patient
- changing type of ventilation (option)
- the ventilator has been totally without power for more than 2 minutes.

7.3.4 LIST OF ALARM SETTINGS

Automatically Set—These settings are determined automatically by the ventilator based on the related parameter settings:

- *O₂ concentration high* (based on O₂ concentration setting)
- *O₂ concentration low* (based on O₂ concentration setting)
- *High continuous pressure* (based on PEEP setting)

Upper Limit—These settings define an upper bound on a condition that is monitored by the ventilator:

- *Paw high* (airway pressure too high)
- *Apnea* (maximum time exceeded)

Breathing Parameter Alarms—These settings define an allowed range for a breathing parameter:

- *Expired minute volume* (high and low)
- *Respiratory rate* (high and low)
- *End Exp. Pressure* (high and low)

8 OPTIONAL ACCESSORIES

TABLE OF CONTENTS

8.1	General	128
8.2	Active humidifiers	128
8.3	Nebulizers	129
8.4	Compressor Mini	130

8.1 GENERAL

Applied parts, i.e. equipment making physical contact with the patient, comprise nebulizer patient unit and cable and the Ventilator Breathing System described in System Flow Chart, Ventilation, Patient Connection, part no. 66 92 522.

8.2 ACTIVE HUMIDIFIERS

The use of an active humidifier is often beneficial for patients undergoing ventilatory treatment.

The following humidifiers can be used with the SERVO-s Ventilator System:

- Fisher & Paykel Humidifier MR850
- Teleflex Medical Conchaterm Neptune Heated humidifier

Please refer to the manufacturer's operating manual for instructions on use.

WARNING! During humidification, carefully monitor the airway pressure. Increased airway pressure could result from a clogged filter. Replace the filter if the expiratory resistance increases or after maximum usage time according to filter specification, whichever comes first.

CAUTION: If the Aeroneb nebulizer is used with active humidification, then the particle size of the medication may be affected.

Important:

- Use only tubes recommended by MAQUET. Soft tubing may negatively affect the performance of the ventilator.
- If a single heated breathing circuit is used in the system a water trap must be used on the expiratory tube to avoid condensation in the system. During operation the water traps must be checked regularly and if necessary emptied.
- Fisher & Paykel's Evaqua circuit can be used as a dual heated breathing circuit with the SERVO-s Ventilator System.
- Accessories connected to the tubing system may cause changes in patient pressure.
- An extended leakage test during Pre-use-check must be performed when using the Teleflex Medical Conchaterm Neptune Heated humidifier. This can be enabled in the *Edit start-up configuration* window.

8.3 NEBULIZERS

8.3.1 GENERAL

The nebulizer is intended for administering drugs to patients requiring mechanical ventilation or positive pressure breathing assistance via an endotracheal tube or face mask/prongs.

The nebulizer operates continuously regardless of ventilation mode setting. No extra gas volume is added to the inspiratory minute volume and ventilator settings and values are not affected

The SERVO-s Ventilator System must not be used with jet nebulizers.

Please refer to the manufacturer's operating manual for instructions on use.

8.3.2 AERONEB NEBULIZER SYSTEM

See Aeroneb Nebulizer System's own User Manual for instructions.

WARNINGS!

- Disconnect the Servo Humidifier/HME during nebulization; otherwise the humidifier may become blocked or the drug may be trapped in the humidifier
- Do not use the nebulizer without a filter e.g. Servo Duo Guard, connected to the expiratory inlet of the ventilator.
- During nebulization, carefully monitor the airway pressure. Increased airway pressure could result from a clogged filter. Replace the filter if the expiratory resistance increases or after maximum usage time according to filter specification, whichever comes first.

CAUTION: If the Aeroneb nebulizer is used with active humidification, then the particle size of the medication may be affected.

CAUTION: The nebulizer must not be left unattended when connected to a patient.

8.4 COMPRESSOR MINI

The Compressor Mini provides a continuous flow of pressurized air in the absence of a central gas supply or gas cylinders.

Using surrounding air, the compressor collects and stores gas for direct use with the SERVO-s Ventilator system as long as the ventilator is active.

Please refer to the Compressor Mini User's Manual.

9 SYSTEM MESSAGES

TABLE OF CONTENTS

9.1	Introduction	132
9.2	High priority alarms	133
9.3	Medium priority alarms	136
9.4	Low priority alarms	138
9.5	Technical error messages	138

9.1 INTRODUCTION

This chapter lists and describes alarms and error messages for technical problems. The lists also suggest actions in response to the messages.

WARNING! Always disconnect the patient from the ventilator when performing operations that increase risk to the patient, such as replacing the O₂ cell.

CAUTION: Do not lift or disconnect the expiratory cassette when the ventilator is operating; instead, you may do this in Standby.

Note: Most technical errors require the attention of a service technician.

9.2 HIGH PRIORITY ALARMS

Alarm Message	Possible causes	Remedies
<i>Apnea</i>	Preset or default alarm limit exceeded. Time between two consecutive inspiratory efforts exceeds the set alarm limit.	Check patient and breathing system. Check ventilator settings.
<i>Check tubing</i>	Problems with patient tubing or expiratory pressure transducer. Disconnected pressure transducer (expiratory or inspiratory). Blocked pressure transducer (expiratory or inspiratory). Water in expiratory limb of ventilator. Wet or clogged bacteria filter. Excessive leakage.	Refer to service. Remove water from tubing and check humidifier settings, e.g., relative humidity. Check heater wires in humidifier (if present). Check connections of tubing and expiratory cassette.
<i>Expiratory cassette disconnected</i>	The expiratory cassette is disconnected or not connected properly.	Connect the expiratory cassette. Replace the expiratory cassette. Perform a Pre-use check if a new expiratory cassette is inserted.
<i>Expiratory Minute Volume: High</i>	Preset or default alarm limit exceeded. Increased patient activity. Ventilator self-triggering (autocycling). Improper alarm limit setting.	Check patient and breathing system. Check trigger sensitivity setting. Check alarm limit settings.
<i>Expiratory Minute Volume: Low</i>	Preset or default alarm limit exceeded. Note: This alarm also works as a patient disconnect alarm. Low spontaneous patient breathing activity. Leakage around the cuff. Leakage in the patient breathing system. Improper alarm setting.	Check patient Check cuff pressure. Check patient breathing system (perform leakage test if necessary). Check pause time and graphics to verify. Consider increased ventilatory support for the patient.
<i>Gas supply pressures: Low</i>	Air and O ₂ supply is below 2.0 kPa x 100. Both air and O ₂ gas supply disconnected.	Check the gas connections.
<i>High continuous pressure</i>	Obstruction leading to constant high airway pressure (>PEEP +15 cmH ₂ O) during: <ul style="list-style-type: none"> ■ > 2 breaths or 5 seconds, whichever is greater, ■ 15 ±1.5 s if less 2 breaths are triggered 	Check patient and breathing system. Check ventilator settings. Contact a service technician.

Alarm Message	Possible causes	Remedies
<i>Leakage out of range</i> (A high priority alarm when NIV disconnect flow is enabled). See section Medium priority alarms.	Leakage too high. The mask / prongs may not be adjusted properly for the patient or may be the wrong size.	Check patient and breathing system. Check mask/ prongs size and patient fit.
<i>Limited battery capacity</i>	Less than 10 minutes left of battery operating time.	Connect to AC power.
<i>Low battery voltage</i>	Battery voltage too low. Cannot guarantee continued ventilator operation.	If possible, connect to AC power supply. Replace and discard all batteries if this message appears even when batteries are fully charged.
<i>No battery capacity</i>	Less than 3 minutes left of battery operation.	Connect to AC power.
<i>No consistent patient effort</i>	The ventilator has switched between supported and backup ventilation four times in two minutes. The patient has only triggered a single breath to interrupt each of two consecutive backup periods	Check patient and breathing system. Check ventilator settings.
<i>No patient effort</i>	An apnea has caused the ventilator to switch to backup ventilation.	Check patient and breathing system. Check ventilator settings.
<i>O₂ cell / sensor failure</i>	O ₂ cell / sensor missing or disconnected.	Check O ₂ cell / sensor and connection.
<i>O₂ concentration: High</i>	Measured O ₂ concentration exceeds the set value by more than 5 Vol.%. Gas supply or air line disconnected. No supply from wall outlet. The air gas module is disconnected. If no gas is available, then both expiratory and safety valves will open.	Check air supply. Perform a Pre-use check. Perform O ₂ cell adaptation.
<i>O₂ concentration: Low</i>	Measured O ₂ concentration is below the set value by more than 5 Vol.% or concentration is below 18 Vol.% which is independent of operator settings. Gas delivered in O ₂ supply line is not O ₂ . O ₂ sensor faulty or exhausted. O ₂ cell uncalibrated. O ₂ /oxygen gas module faulty.	Check O ₂ supply line. Perform a Pre-use check. Perform O ₂ cell adaptation.

Alarm Message	Possible causes	Remedies
Paw high	Airway pressure exceeds preset Upper Pressure Limit. Kinked or blocked tubing. Mucus or secretion plug in endotracheal tube or in airways. Patient coughing or fighting ventilator. Inspiratory flow rate too high. Improper alarm setting. Blocked expiratory filter.	Check patient and breathing system. Check ventilator settings and alarm limits.
<i>Restart ventilator!</i>	Software error.	Restart the ventilator and perform a Pre-use check. Contact a service technician.
<i>Safety valve test failed</i>	During Pre-use check the system found problems with the opening pressure for the safety valve.	Contact a service technician.
<i>Settings lost; Restart ventilator</i>	Software error, memory corrupt.	Restart the ventilator and perform a Pre-use check. Check ventilator settings.
Technical error in Expiratory cassette	Technical problem with the expiratory cassette.	Perform a Pre-use check. Change the expiratory cassette and perform a Pre-use check. Contact a service technician.
Technical error: Restart ventilator	Ventilator settings lost.	Restart the ventilator, perform a Pre-use check and check all settings. Contact a service technician.
Time in waiting position exceeds 2 min.	Time in waiting position is exceeded. Patient is not connected to the ventilator or leakage is excessive.	Check patient and breathing system.

9.3 MEDIUM PRIORITY ALARMS

Alarm Message	Possible causes	Remedies
<i>Air supply pressure: High</i>	Air supply pressure above 6.0 kPa x 100 (87 psi) Air supply pressure at gas inlet is too high.	Check the gas supply lines. Perform a Pre-use check. Contact a service technician.
<i>Air supply pressure: Low</i>	Air supply pressure below 2.0 kPa x 100 (29 psi) Air supply pressure at gas inlet is too low. Gas supply line disconnected. Note: This alarm can be permanently silenced (Audio off) when activated.	Check and connect gas supply lines. Perform a Pre-use check.
<i>Alarm output connection error</i>	Technical problems (hardware or software) with the external alarm function.	Contact a service technician.
<i>Battery operation</i>	AC power interrupted.	Check the connection to AC power.
<i>Check alarm limits</i>	The persistent memory has corrupt contents.	Check the alarm limits.
<i>Check default alarm limits</i>	Problems in internal memory for default alarm limits.	Check default alarm limits. Contact a service technician.
<i>Exp. cassette exchanged</i>	Expiratory cassette has been exchanged during operation. Pre-use check not performed after exchange.	Perform a Pre-use check.
<i>Inspiratory flow overrange</i>	Combination of settings exceeds the allowable inspiration flow range.	Change ventilator settings.
<i>Internal temperature: High</i>	Temperature inside the ventilator is too high.	Check fan operation. Check the operating temperature. Clean the fan filter in the patient unit.
<i>Leakage out of range (A medium priority alarm when NIV disconnect flow is disabled). See section High priority alarms.</i>	Leakage too high. The mask / prongs / helmet may not be adjusted properly for the patient or may be the wrong size.	Check patient and breathing system. Check mask/ prongs size and patient fit. Check the helmet leakage.
<i>O₂ supply pressure: High</i>	O ₂ supply pressure above 6.0 kPa x 100. O ₂ supply pressure at gas inlet is too high.	Check the gas supply lines. Perform a Pre-use check. Contact a service technician.
<i>O₂ supply pressure: Low</i>	O ₂ supply pressure below 2.0 kPa x 100. O ₂ supply pressure at gas inlet is too low. Gas supply line disconnected. Note: This alarm can be permanently silenced (Audio off) when activated.	Check and connect gas supply lines. Perform a Pre-use check.
<i>Panel disconnected</i>	No communication between user interface and patient unit.	Check control cable. Contact a service technician.

Alarm Message	Possible causes	Remedies
<i>PEEP High</i>	The measured end expiratory pressure is above the preset or default alarm limit for three consecutive breaths.	<ul style="list-style-type: none"> Check patient breathing system. Check patient connection (cuff pressure/tracheal tube size). Perform a Pre-use check. Check ventilator settings. Check alarm settings.
<i>PEEP Low</i>	<ul style="list-style-type: none"> The measured end expiratory pressure is below the preset or default alarm limit for three consecutive breaths. Setting the alarm to zero turns the alarm off. Leakage in patient breathing system. Leakage at patient connection (cuff, tracheal tube). 	<ul style="list-style-type: none"> Check patient breathing system. Check patient connection (cuff pressure/tracheal tube size). Perform a Pre-use check. Check alarm settings.
<i>Regulation pressure limited</i>	<ul style="list-style-type: none"> It is not possible to reach the Set volume in PRVC due to restrictions imposed by the set upper pressure limit. Set high pressure alarm limit; this limits the regulatory pressure used in PRVC. 	<ul style="list-style-type: none"> Check ventilator settings.
<i>Respiratory Rate: High</i>	<ul style="list-style-type: none"> Respiratory rate too high. Auto triggering. 	<ul style="list-style-type: none"> Attend to the patient. Check the trigger setting.
<i>Respiratory Rate: Low</i>	<ul style="list-style-type: none"> Respiratory rate too low. Trigger sensitivity setting incorrect. Large tidal volume. 	<ul style="list-style-type: none"> Attend to the patient. Check trigger setting. Check inspiratory cycle-off setting.
<i>VT inspiratory overrange</i>	<ul style="list-style-type: none"> Setting causing larger volume than allowed for the selected category. Limited adjustment of excessive tidal volume. 	<ul style="list-style-type: none"> Check the adjustment for the inspiratory tidal volume.

9.4 LOW PRIORITY ALARMS

Alarm message	Possible causes	Remedies
<i>Touch screen or knob press time exceeded</i>	Screen or knob has been pressed for more than one minute. Screen or knob hardware time out.	Check screen and knobs. Contact a service technician.

9.5 TECHNICAL ERROR MESSAGES

Error code number	Causes	Remedies
<i>xxxx (General)</i>	Technical problem, identified by the error code xxxx.	Restart the ventilator and perform a Pre-use check. Contact a service technician.
<i>1 - 6, 29, 10001</i>	Internal power error.	Contact a service technician.
<i>7, 10-12, 16</i>	Control system error	Contact a service technician.
<i>43</i>	Battery information error	Contact a service technician.
<i>28, 20004</i>	Audible alarm/ loudspeaker error	Check that the loudspeaker outlet is not obstructed. Restart the ventilator and perform a Pre-use check. Contact a service technician.
<i>41</i>	Internal clock error	Contact a service technician.
<i>25, 33-35, 50, 10002, 20001</i>	Internal communication error	Contact a service technician.
<i>38-39</i>	Barometer error	Contact a service technician.
<i>46</i>	Alarm output connection error	Contact a service technician.
<i>47</i>	Fixed battery missing	Contact a service technician.
<i>8-9, 48-49</i>	Timeout error	Contact a service technician.
<i>22, 24, 27</i>	Backup audible alarm error	Restart the ventilator and perform a Pre-use check. Contact a service technician.
<i>20002</i>	Backlight error	Contact a service technician.
<i>20003</i>	Membrane button error	Check the user interface buttons. Contact a service technician.
<i>51</i>	Technical problem with On/Off switch.	Contact a service technician.
<i>40001</i>	Exp. flow meter error	Contact a service technician.
<i>40, 42, 44, 45, 50, 54, 10003, 20005</i>	Other error	Restart the ventilator and perform a Pre-use check. Contact a service technician.

10 START-UP CONFIGURATION

TABLE OF CONTENTS

10.1	Introduction	140
10.2	Access the Start-Up Configuration	140
10.3	Edit the Start-up Configuration	141
10.4	Start MCare Remote Service	142

10.1 INTRODUCTION

This section provides instructions for accessing and editing the start-up configuration and changing the type of ventilation.

The ventilator will always start up with the stored Start-Up Configuration. The Start-Up Configuration can be edited, copied, and saved.

You can edit the following Start-Up Configuration settings:

- Type of ventilation - invasive or non invasive (NIV)
- Volume setting
- Breath cycle setting
- Pre/post oxygenation concentration above set O₂ concentration (%)
- Option to deactivate backup ventilation (Disabled or Enabled)
- NIV disconnect function (Low flow, High flow or Disabled)
- Extended leakage test during pre-use check
- Volume Control with alternative flow patterns

10.2 ACCESS THE START-UP CONFIGURATION

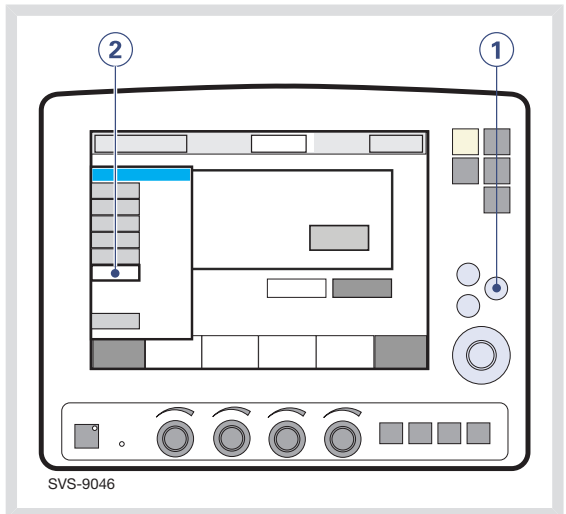

Note: The ventilator must be in Standby.

1. Press the *Menu* fixed key.
2. Press the *Biomed* touchpad and enter the access code (the factory setting is 1973).

The *Biomed* submenu consists of the following touchpads:

- *Service*
- *Edit configuration*
- *Copy configuration*
- *Set date and clock*
- *Change access code*
- *Start MCare Remote Service*

To alter ventilator settings, press the appropriate touchpad and follow on-screen instructions.

10.3 EDIT THE START-UP CONFIGURATION

To edit the Start-up Configuration.

1. Press the *Edit configuration* touchpad in the *Biomed* submenu.
2. Press the *Start-up configuration* touchpad.
3. Press the touchpad for desired start-up setting.
4. Press *Next* to continue to ventilation mode settings.
5. Press the appropriate touchpad to change the settings.

Note: Press *Restore mode settings* to restore factory default settings.

6. Press *Next* to view a summary of the start-up configuration.
7. Press *Accept* to save the start-up settings.

Note: The ventilator must be restarted to activate the new settings.

10.3.1 PROCEDURE DIAGRAM: EDIT THE START-UP CONFIGURATION

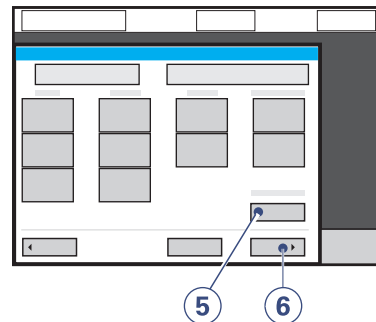
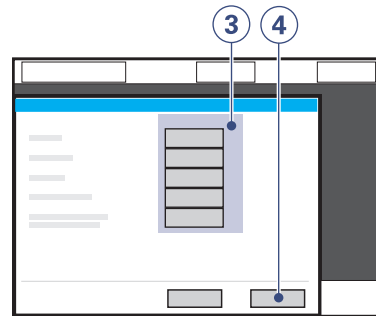
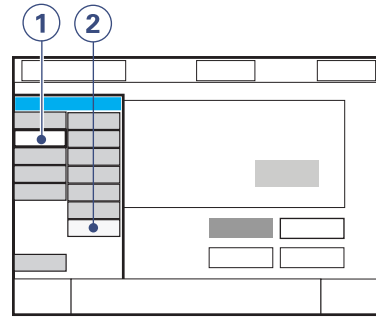

SVS-9045_XX

10.4 START MCARE REMOTE SERVICE

Connect the network cable between the SERVO-s Ventilator System (1) and the docking station.

WARNING! Only use network equipment that has been installed by a MAQUET representative.

CAUTION: When using the MCare Remote Service function, install the network cable so that there is no risk of anyone tripping over it.

Activate the MCare Remote Service function by pressing the *Start MCare Remote Service* touchpad (2) in the *Biomed* window.

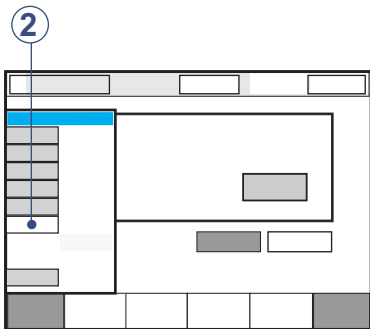

The following message appears in Standby (3) - *MCare Remote Service is activated. Make sure the network cable is connected and Progress: Waiting for transfer....*, followed by *Sending log files.*

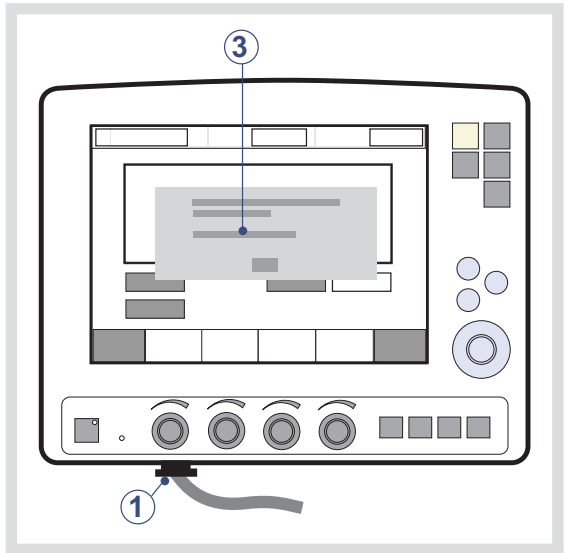

When the transfer is finished, the message *The file transfer is completed. MCare Remote Service will be deactivated. Disconnect the network cable.*

Accept the dialog by pressing *OK* and the MCare Remote Service is deactivated.

WARNING! Always disconnect the network cable before starting ventilation.

Note: The SERVO-s Ventilator System is prepared for the MCare Remote Service functionality, although additional equipment is needed to utilise this function. Please contact your sales and service representative for more details.

11 TECHNICAL DATA

TABLE OF CONTENTS

11.1	System	144
11.2	Ventilator	146
11.3	Standard condition specification	147
11.4	Patient circuit	148
11.5	Inspiratory channel	148
11.6	Expiratory channel	149
11.7	Monitoring	149
11.8	Breathing parameters: default values & allowed settings (standard configuration)	151
11.9	Alarms	153
11.10	Functions in ventilation modes	154
11.11	Trend function	155
11.12	Log function	156
11.13	Immediate functions	156
11.14	Communication/interface	156
11.15	Service	157
11.16	Accessories	157
11.17	Pollution control	158
11.18	Information required by ISO 80601-2-12	159
11.19	UDI Label	161

11.1 SYSTEM

11.1.1 GENERAL

Standards

- EN/IEC 60601-1: 2005, continuous operation
- ISO 80601-2-12:2011
- ISO 80601-2-55:2011

Electromagnetic compatibility (EMC)

According to IEC 60601-1-2:2007

The EMC declaration: *Information to the Responsible Organization* is available from MAQUET.

Patient Range (kg)

Weight 10 – 250 kg.

IP classification

IP 21²

The IP 21 classification implies that the enclosure is protected against solid foreign objects represented by a test finger with a diameter of 12 mm pressed with a force of 10 N, and a sphere with a diameter of 12.5 mm pressed with a force of 30 N against all openings in the enclosure, as well as dripping water with a flow rate of 1 ml/min for ten minutes.

Noise

- A-weighted sound pressure level (L_{pA}): <41 dB, measured at a distance of 1 m
- A-weighted sound power level (L_{WA}): <50 dB

11.1.2 OPERATING CONDITIONS

- Operating Temperature range: +10 to +40°C
- Relative humidity: 15 to 95% non-condensing
- Atmospheric pressure: 660 to 1060 hPa
- Lowest pressure in patient circuit: -400 cmH₂O

Mechanical strength

Vibration, shock and fall according to specified standards with the addition of impact below.

- Peak acceleration: 15 g
- Pulse duration: 6 ms
- Number of impacts: 1000

11.1.3 NON OPERATING CONDITIONS

- Storage temperature: -25 to +60°C (-13 to 140°F)
- Storage relative humidity: < 95%.
- Storage atmospheric pressure: 470 – 1060 hPa

2. from serial no. 25001

11.1.4 POWER SUPPLY

Storage temperature

15 - 20°C (59 - 68°F)

Power supply, automatic range selection

- 100-120V, 220-240V, AC 50-60Hz
- Allowed fluctuations $\pm 10\%$ from nominal voltage.

Battery backup

- 2 rechargeable battery modules 12 V, 5 A, 3.5 Ah each.
- Recharge time approximately 3 h/battery (up to 12 hours if battery is completely discharged)
- Battery backup time approximately 1 h, when using 2 fully charged batteries.

External 12V DC

12.0 V – 15.0 V DC, 10 A

Fuse: 10 A/32 V Miniblade



Information regarding connector wiring and EMC performance is available from MAQUET.

CAUTION: When using external 12V DC, at least two installed battery modules are required to ensure proper operation.

Max power consumption

- At 110-120V: 2A, 190VA, 140W.
- At 220- 240V: 1A, 190VA, 140W.

On/Off switch (Set to On; when off, battery continues to charge)

Battery lifetime

2.5 years from manufacture date

11.2 VENTILATOR

11.2.1 GENERAL

Dimensions (mm)

- Patient Unit: W 380 x D 300 x H 210
- User Interface: W 355 x D 53 x H 295
 - Screen type: TFT-LCD module
 - Screen size: 31 cm (12.1") diagonal
 - Viewing area: 246.0 x 184.5 mm

Weight, approximate (kg)

18

Triggering method

- Flow and pressure

11.2.2 GAS SUPPLY

Gas quality

Supplied gases shall meet the requirements for medical grade gases according to applicable standards.

Maximum levels

Air

- $H_2O < 7 \text{ g/m}^3$
- Oil $< 0.5 \text{ mg/m}^3$
- Chlorine: must not be detectable³

Oxygen

- $H_2O < 20 \text{ mg/m}^3$
- Oil $< 0.3 \text{ mg/m}^3$

Inlet gas

- Pressure: 2.0 – 6.0 kPa x 100 (29 – 87 psi)
- \dot{V}_{max} 60 l/min

Connection standards available

AGA, DISS, NIST, or French.

Unavailable gas/loss of gas pressure

The flow from an unavailable gas (air or O₂) is automatically compensated for so that the patient gets the preset volume and pressure.

11.2.3 PATIENT SYSTEM CONNECTORS

Conical fittings (mm)

Male 22 and female 15, in accordance with ISO 5356-1.

Gas exhaust port (mm)

Male 30 cone.

3. If the compressed air is generated by a liquid ring compressor there is a potential risk of chlorine in the supplied air.

11.3 STANDARD CONDITION SPECIFICATION

Inaccuracy ranges in this document assume the following standard conditions and the worst case, i.e. all errors are summarized positive. Statistically 95% of all values will be within 2/3 of the given error.

- Ambient pressure: 101.3 kPa
- Room temperature: 20 °C
- Inlet pressure: 4.3 kPa x 100
- Pre-use check performed on a warmed up ventilator
- Pre-use check performed with $\geq 99\%$ oxygen content in O₂ supply.
- Pre-use check performed with $21 \pm 0.5\%$ oxygen content in air supply.

- Patient circuit compliance compensation is activated.
- Default settings unless otherwise specified
- All measured, preset and indicated flows and volumes are referenced to BTPS, see chapter Definitions on page 163.
- All measured, inlet gas pressures and flows are referenced to STPD, see chapter Definitions on page 163.
- Humidifier water level is between 50 % and 100 % of the maximum level.
- Set I:E is less than 1:1.
- Set ventilatory frequency is less than or equal to 100 breaths/minute.
- Inaccuracy does not include measurement uncertainty. Values including measurement uncertainty are specified in the service documentation available from MAQUET.
- Constant leakage fraction below 30 % in NIV modes.

11.4 PATIENT CIRCUIT

The patient circuit configuration are intended to provide the following range of inspired tidal volume:

- 22 mm tubing, Tidal Volumes 100 - 2000 ml.

For information regarding patient circuit configurations to be used with SERVO-s Ventilator System, see System Flow Chart, Ventilation, Patient Connection, part no. 66 92 522.

11.4.1 PATIENT CIRCUIT TEST

In the Pre-use check, the patient circuit is tested to determine if it is within these recommended ranges. If the tested parameters are within the specified ranges, the inaccuracies stated are maintained.

- Inspiratory resistance: 0 - 8.5 cmH₂O/l/s at flow rate 60 l/min
- Expiratory resistance: 0 - 8.5 cmH₂O/l/s at flow rate 60 l/min
- Compliance: 0.5 - 5.0 ml/cmH₂O at airway pressure 50 cmH₂O.

The limits used in the presentation under *Status>Patient Circuit* are adjusted for measurement inaccuracy.

11.5 INSPIRATORY CHANNEL

Pressure drop

Maximum: 6 cmH₂O at a flow of 60 l/min

Internal compressible factor

Maximum: 0.1 ml/cmH₂O

Gas delivery system

Microprocessor controlled valves

Gas delivery device

Flow range:

- 0 - 3.3 l/s
- Inaccuracy: $\pm(0.1 \text{ ml/s} + 5 \% \text{ of set value})$

Maximum pressure setting

- 120 cmH₂O
- Inaccuracy: $\pm(1 \text{ cmH}_2\text{O} + 5 \% \text{ of set value})$

Maximum airway pressure

125 cmH₂O

NIV Max leakage compensation level

65 l/min

O₂ concentration

- Setting range: 21 - 100%
- Inaccuracy: $\pm 3 \text{ vol\% O}_2$

Inspiratory Minute Volume

- Setting range: 0.5 - 60 l/min
- Inaccuracy $\pm(0.18 \text{ l/min} + 7 \% \text{ of set value})$ ⁴

Inspiratory Tidal Volume

- Setting range: 100 - 2000 ml
- Inaccuracy: $\pm(4 \text{ ml} + 7 \% \text{ of set volume})$

4. at RR <45 b/min

11.6 EXPIRATORY CHANNEL

Pressure Drop

Maximum: 3 cmH₂O at a flow of 60 l/min

Internal Compressible Factor

Maximum: 0.1 ml/cmH₂O

PEEP Regulation

Microprocessor controlled valve

PEEP setting range:

- 0 - 50 cmH₂O
- Inaccuracy: $\pm(1 \text{ cmH}_2\text{O} + 5 \% \text{ of set value})$

Expiratory Flow Measurements

- 0 - 3.2 l/s
Inaccuracy: $\pm 5\%$ or $\pm 2.5 \text{ ml/s}$
- Rise time (flow of 0.05 - 3.2 l/s): <12 ms for 10 - 90% response
Inaccuracy: $\pm 5\%$ or $\pm 2.5 \text{ ml/s}$

Bias flow during expiration

2 l/min

11.7 MONITORING

Inspiratory Tidal Volume

- Range: 0 - 2000 ml
- Inaccuracy: $\pm(4 \text{ ml} + 7 \% \text{ of actual volume})$ for V_T 100 ml - 2000 ml

Expiratory Minute Volume

- Range: 0 - 60 l/min
- Inaccuracy: $\pm(0.18 \text{ l/min} + 8 \% \text{ of actual value})^5$
- NIV: $\pm 10\%$

Expiratory Tidal Volume

- Range: 0 - 2000 ml
- Inaccuracy: $\pm(4 \text{ ml} + 8 \% \text{ of actual volume})$ for V_T 100 ml - 2000 ml

Respiratory rate

- Range: 1 - 160 b/min
- Inaccuracy:
- $\pm 1 \text{ b/min}$

O₂ Concentration

- Range: 0 - 100%
- Inaccuracy: $\pm(2.5 \text{ vol}\% + 2.5 \% \text{ of actual gas concentration})$
- Stability (within 8-hour period): $\pm(2.5 \% \text{ volume} + 2.5 \% \text{ of actual gas concentration})$

The inaccuracy of the measurement is dependant on the oxygen content of the supplied gases during the Pre-use check.

System response time O₂

The total system response time of the O₂ monitor when exposed first to air and then to a gas mix with 60 % O₂ is <20 s.

Barometric pressure compensation

Automatic

5. at RR <45 b/min

Airway Pressure

- Range: -40 - 160 cmH₂O
- Inaccuracy: $\pm(1 \text{ cmH}_2\text{O} + 5 \% \text{ of actual value})$

Supply Pressure

- Range: 0 - 7 bar
- Inaccuracy: $\pm 5\%$ of read value

Filtering

Pressure waveform: Low pass filtered (time constant 15 ms)

The measured and calculated values displayed or used for control have in some cases been subjected to filtering and smoothing techniques. This is done to capture the important patterns in the data while excluding noise and make the data shown clinically relevant. These techniques are part of the inaccuracy specified in the technical data.

11.8 BREATHING PARAMETERS: DEFAULT VALUES & ALLOWED SETTINGS (STANDARD CONFIGURATION)

Parameter	Factory set default	Setting range
Bias flow (l/min)	2	-
Breath cycle time, SIMV (s)	4	1 - 15
CMV frequency (b/min)	15	4 - 100
Compensate for compliance	OFF	ON/ OFF
Flow trig sensitivity level (fraction of bias flow)	50%	0 - 100%
I:E ratio	1:2	1:10 - 4:1
I:E ratio in backup	1:2	1:10 - 4:1
Inspiratory cycle-off (% of peak flow)	30	1 - 70
Inspiratory cycle-off (% of peak flow) in NIV	50	10 - 70
Inspiratory rise time (%)	5	0 - 20
Inspiratory rise time (s)	0.15	0 - 0.4
Inspiratory rise time (s) in NIV	0.2	0 - 0.4
Maximum inspiratory flow (l/s)	3.3	-
Maximum permitted absolute pressure (cmH ₂ O)	120	-
Maximum permitted absolute pressure in NIV (cmH ₂ O)	32	-
Minute Volume (l/min)	7.5	0.5 - 60
Mode (Invasive ventilation)	VC	-
Mode (Non invasive ventilation)	PS	-

Parameter	Factory set default	Setting range
O ₂ concentration (%)	40	21 - 100
PEEP (cmH ₂ O)	5	0 - 50
PEEP in NIV (cmH ₂ O)	5	2 - 20
Phigh (cmH ₂ O)	15	(PEEP+1) - 50
Press trig sensitivity level (cmH ₂ O)	-	-20 - 0
Pressure level above PEEP (cmH ₂ O)	20	0 - (120 - PEEP)
Pressure level above PEEP in NIV (cmH ₂ O)	5	0 - (32 - PEEP)
Pressure level above PEEP in backup (cmH ₂ O)	20	5 - (120 - PEEP)
Pressure level above PEEP in NIV backup (cmH ₂ O)	5	5 - (32 - PEEP)
PS above PEEP in Bivent (cmH ₂ O)	0	0 - (120 - PEEP)
PS above Phigh in Bivent (cmH ₂ O)	0	0 - (120 - P _{High})
Resp rate in backup	15	4 - 100
SIMV frequency (b/min)	5	1 - 60
Thigh (s)	2	0.2 - 10
Ti (s)	0.9	0.1 - 5
Ti in backup (s)	0.9	0.1 - 5
Tidal Volume (ml)	500	100 - 2000
Tidal volume in backup (ml)	500	100 - 2000
Tpause (%)	10	0 - 30
Tpause (s)	0.4	0 - 1.5
TPEEP (s)	2	0.2 - 10
Weight (kg)	50	10 - 250

11.9 ALARMS

11.9.1 ALARM LIMITS

Parameter	Factory set default	Setting range	Audio Off (only for NIV)
Airway pressure, upper limit (cmH ₂ O) ⁶	40	16 - 120	No
Airway pressure, upper limit (cmH ₂ O) in NIV ⁷	20	16 - 40	No
Apnea time to alarm (s)	20	15 - 45	No
End expiratory pressure, high limit (cmH ₂ O) ⁸	2	0 - 47	Yes
End expiratory pressure, lower limit (cmH ₂ O)	10	0 - 55	Yes
Expired minute volume, lower limit (l/min)	5.0	0.5 - 40.0	Yes
Expired minute volume, upper limit (l/min)	40.0	0.5 - 60.0	Yes
Respiratory rate, lower limit (b/min)	5	1 - 160	Yes
Respiratory rate, upper limit (b/min)	30	1 - 160	Yes
O ₂ concentration high	-	Set value + 5 vol%	No
O ₂ concentration low	-	Set value - 5 vol% or ≤ 18 vol%	No
Gas supply	<2.0 kPa x 100 or >6.0 kPa x 100	-	-
High continuous pressure	-	Obstruction leading to constant high airway pressure (>PEEP +15 cmH ₂ O) during: <ul style="list-style-type: none"> ■ > 2 breaths or 5 seconds, whichever is greater, ■ 15 ±1.5 s if less 2 breaths are triggered 	No

6. If P_{aw} rises 6 cmH₂O above the set limit or if system pressure exceeds 117 ±7 cmH₂O, the safety valves opens.

7. If P_{aw} rises 6 cmH₂O above the set limit or if system pressure exceeds 117 ±7 cmH₂O, the safety valves opens.

8. Setting the alarm limit to 0 (zero) is equivalent to turning off the alarm.

Default values are set when:

- restarting the ventilator
- admitting a new patient
- changing type of ventilation (option)
- the ventilator has been totally without power for more than 2 minutes.

Always make sure relevant values are set.

11.9.2 AUTOSET ALARM LIMITS - CONTROLLED MODES ONLY

High Airway Pressure

Mean peak pressure +10 cmH₂O or at least 35 cmH₂O

Expiratory Minute Volume (Upper alarm limit)

+ 50%

Expiratory Minute Volume (Lower alarm limit)

- 50%

Respiratory rate (Upper alarm limit)

+ 40%

Respiratory rate (Lower alarm limit)

- 40%

End Expiratory Pressure (Upper alarm limit)

Mean End Expiratory Pressure + 5 cmH₂O

End Expiratory Pressure (Lower alarm limit)

Mean End Expiratory Pressure - 3 cmH₂O

11.9.3 ALARMS MISCELLANEOUS

Audio Pause (Alarm silence/reset)

Two-minute silence and reset of latched alarms.

11.10 FUNCTIONS IN VENTILATION MODES

Maximum inspiration time

- 2.5 s

NIV disconnect function

- Low flow: 7.5 l/min
- High flow: 40 l/min
- Disabled: The ventilator will continue to deliver assist even when leakage is excessive.

11.11 TREND FUNCTION

Peak Airway Pressure	Ppeak
Pause Airway Pressure	Pplat
Mean Airway Pressure	Pmean
Positive End Expiratory Pressure	PEEP
Spontaneous breaths per minute	RRspont
Breathing frequency	RR
Spontaneous Exp. Minute Volume	MVe sp
Inspired Minute Volume	MVi
Expired Minute Volume	MVe
Leakage fraction (%)	Leakage
Inspired Tidal Volume	VTi
Expired Tidal Volume	VTe
End Expiratory Flow	\dot{V}_{ee}
Measured Oxygen Concentration	O ₂
Dynamic Characteristics	Cdyn
Static Compliance	Cstatic
Inspiratory Resistance	Ri
Expiratory Resistance	Re
Work of Breathing ventilator	WOB v
Work of Breathing patient	WOB p
Elastance	E
P0.1	P0.1
Shallow Breathing Index	SBI

11.12 LOG FUNCTION

Event Log

- Alarms
- Ventilator settings
- Apnea periods
- Immediate functions

It is possible to display up to 1000 recorded events in chronological order.

Service Log

- Technical alarms
- Test results
- Preventive maintenance
- Service report history
- Configuration log

11.13 IMMEDIATE FUNCTIONS

Oxygen Breaths

100% for 1 minute.

Start Breath

Initiation of 1 breath in all modes.

(In SIMV mode initiation of one mandatory breath).

Pause Hold

Inspiratory or expiratory.

11.14 COMMUNICATION/INTERFACE

Serial Port

RS-232C-isolated. For data communication via the Communication Interface Emulator (CIE).

Information regarding connector wiring and EMC performance is available from MAQUET.

Communication Interface Emulator (CIE)

A protocol for data communication with external devices. The SERVO-s Ventilator System software v7.0 uses CIE Protocol version 004. This protocol is compatible with previous versions although all data may not be available.

Alarm Output Connection (Option)

Isolated 4-pole modular connector for communication of high and medium priority alarms. The alarm output connection option is a non-guaranteed alarm in accordance with IEC60601-1-8.

Switching capability: Max 40 V DC, Max 500 mA, Max 20 W.

Information regarding connector wiring and EMC performance is available from MAQUET.

11.15 SERVICE

WARNINGS!

- Preventive maintenance must be performed by authorized personnel at least once a year or after every 5000 hours of operation. The Status menu on the user interface shows the current operating time.
- Service, repair and installation must be performed by MAQUET authorized personnel only.
- All technical documentation is available for use by MAQUET-authorized personnel.
- Service mode should only be used without a patient connected to the ventilator.

CAUTION:

Original parts from MAQUET must be used.

Battery module replacement, see page 36 for information.

11.16 ACCESSORIES

11.16.1 MOBILE CART (OPTION)

Weight (kg)

25

Dimensions (mm)

W 500 x L 650 x H 830
with handles 1030

11.16.2 SHELF BASE (OPTION)

Weight (kg)

0.1

Dimensions (mm)

W 80 X L 160 X H 8

11.16.3 COMPRESSOR MINI (OPTION)

Dimensions (mm)

W 430 x D 330 x H 250

Weight (approximate, kg/lbs)

26/70

Power supply

115 V AC, 60 Hz (single phase).

220–240 V AC, 50/60 Hz (single phase).

Compressor capacity

Continuous flow at normal atmospheric pressure (approximately 1013 hPa) 30 l/min (expanded to ambient air pressure) at 3.5 kPa x 100 (bar)/50 psi.

11.16.4 SERVO DUO GUARD

For further information, see the Servo Duo Guard User's Manual.

11.16.5 SERVO GUARD

For further information, see the Servo Guard User's Manual.

11.17 POLLUTION CONTROL

This product complies with environmental protection use period as defined in People's Republic of China Electronic Industry Standard SJ/T11364-2006.



Toxic or hazardous substances will not leak or mutate under normal operating conditions for 50 years.

11.17.1 HAZARDOUS SUBSTANCES

The following table shows the names and contents of toxic or hazardous substances in this product as defined in People's Republic of China Electronic Industry Standard SJ/T11364-2006.

Parts	Hazardous substances					
	Pb	Hg	Cd	Cr ⁶⁺	PBB	PBDE
Metal parts	0	0	0	X	0	0
Plastic and polymeric parts	0	0	0	0	0	0
Electrical components	X	0	0	0	0	0
LCD display	0	0	0	0	0	0

0: Indicates that this toxic or hazardous substance contained in all of the homogeneous materials for this part is below the limit and meets the requirement in SJ/T11363-2006.

X: Indicates that this toxic or hazardous substance contained in at least one of the homogeneous materials used for this part is above the limit requirement in SJ/T11363-2006.

11.18 INFORMATION REQUIRED BY ISO 80601-2-12

11.18.1 VOLUME-CONTROLLED BREATH TYPE

Characteristics valid for patient categories and circuit configurations intended to provide the indicated tidal volume, at conditions specified in ISO 80601-2-12, table 201.103.

Maximum inaccuracy of inspired tidal volume (V_T)

- $\pm(4 \text{ ml} + 7 \% \text{ of set volume})$ for $V_T \geq 300 \text{ ml}$
- $\pm(4 \text{ ml} + 7 \% \text{ of set volume})$ for $100 \text{ ml} \leq V_T \leq 300 \text{ ml}$

Maximum inaccuracy of PEEP

- $\pm(1 \text{ cmH}_2\text{O} + 5 \% \text{ of set value})$ for $V_T \geq 300 \text{ ml}$
- $\pm(1 \text{ cmH}_2\text{O} + 5 \% \text{ of set value})$ for $100 \text{ ml} \leq V_T \leq 300 \text{ ml}$

Maximum inaccuracy of inspired oxygen concentration (FiO_2) at the patient connection port

- $\pm(3 \% + 0 \% \text{ of set value})$ for $V_T \geq 300 \text{ ml}$
- $\pm(3 \% + 0 \% \text{ of set value})$ for $100 \text{ ml} \leq V_T \leq 300 \text{ ml}$

11.18.2 PRESSURE-CONTROLLED BREATH TYPE

Characteristics valid for patient categories and circuit configurations intended to provide the indicated tidal volume, at conditions specified in ISO 80601-2-12, table 201.104.

Maximum inaccuracy of airway pressure (P_{AW}) at the end of the inspiratory phase

- $\pm(1 \text{ cmH}_2\text{O} + 5 \% \text{ of set value})$ for $V_T \geq 300 \text{ ml}$
- $\pm(1 \text{ cmH}_2\text{O} + 5 \% \text{ of set value})$ for $100 \text{ ml} \leq V_T \leq 300 \text{ ml}$

Maximum inaccuracy of PEEP

- $\pm(1 \text{ cmH}_2\text{O} + 5 \% \text{ of set value})$ for $V_T \geq 300 \text{ ml}$
- $\pm(1 \text{ cmH}_2\text{O} + 5 \% \text{ of set value})$ for $100 \text{ ml} \leq V_T \leq 300 \text{ ml}$

Maximum inaccuracy of inspired oxygen concentration (FiO_2) at the patient connection port

- $\pm(3 \% + 0 \% \text{ of set value})$ for $V_T \geq 300 \text{ ml}$
- $\pm(3 \% + 0 \% \text{ of set value})$ for $100 \text{ ml} \leq V_T \leq 300 \text{ ml}$

11.18.3 O₂ CONCENTRATION RESPONSE TIME

Characteristics valid at conditions specified in ISO 80601-2-12, table 201.105.

Response time for oxygen concentration to change from 21 % to 90 %

- Maximum 25 s at $V_T = 500$ ml, for patient categories and circuit configurations intended to provide $V_T \geq 300$ ml
- Maximum 35 s at $V_T = 150$ ml, for patient categories and circuit configurations intended to provide $100 \text{ ml} \leq V_T \leq 300$ ml

11.19 UDI LABEL

UDI Label

Unique Device Identification number	Global standard for identifying Medical Equipment, example: (01)07325710000007(11)140625(21)01311141
Application Identifier (AI)	Each UDI number can be divided into several parts, each referred to by their AI number '#).
(01)	GTIN - Global Trade Item Number
(241)	Part number
(10)	Batch no.
(11)	Manufacturing date (YYMMDD)
(17)	Exp. date (YYMMDD)
(20)	Revision
(21)	Serial number
(30)	Count of items

The GTIN consists of four parts:

- Package level
- GS-1 company prefix
- Item reference
- Check digit

0 732571 000021 2
 a b c d

12 DEFINITIONS

b/min—Breaths per minute

Bias flow—The continuous flow during the expiratory phase

Breath cycle time—Total cycle time per mandatory breath in SIMV (inspiratory + pause + expiratory). Set in seconds.

BTPS - Body Temperature and Pressure Saturated. All measured, preset and indicated flows and volumes at +37°C, local atmospheric pressure and relative humidity 100 % (saturated).

Cdyn—Dynamic characteristics

CMV—Controlled Mechanical Ventilation

CPAP—Continuous Positive Airway Pressure

Cstatic—Static compliance, respiratory system

E—Elastance

Expiratory hold—Manual closure of inspiration and expiration valves after expiration (max. 30 seconds). Measures Total PEEP.

Flow trigger level—The flow that the patient must inhale to trigger the ventilator to deliver a breath (fraction of the bias flow).

HME—Heat and moisture exchanger

I:E—Inspiration to Expiration ratio (only during controlled ventilation)

Inspiratory hold—Manual closure of inspiration and expiration valves after inspiration (max. 30 seconds). Measures plateau pressure.

Inspiratory cycle-off—Fraction of maximum flow at which inspiration should switch to expiration (%)

Inspiratory rise time—Time to full inspiratory flow or pressure at the start of each breath, as a percentage or in seconds of the breath cycle time (% or s)

Leakage - leakage in relation to inspiratory flow (%)

Minute Volume—Volume per minute or target volume (l)

MVe—expiratory Minute Volume

MVe sp—Spontaneous expiratory minute volume

MVe sp / MVe—The ratio of spontaneous expired minute volume to total expired minute volume (only applicable in Bi-Vent)

MVi—inspiratory Minute Volume

O₂—Oxygen concentration in vol. %

O₂ breaths—100% oxygen for one minute.

Option—Optional, add-on functionality or accessory

NIV—Non Invasive Ventilation

P—Pressure

P0.1—Indicator for respiratory drive

Pause time—Time for no flow or pressure delivery (%)

PC—Pressure Control

PEEP—Positive end expiratory pressure (cmH₂O)

PEEP_{tot}— Set PEEP + Intrinsic PEEP

Paw—Airway pressure

Ppeak—Maximum inspiratory pressure

P_{high}—High pressure level

P_{mean}—Mean airway pressure

P_{plat}—Pressure during end-inspiratory pause

Pressure trigger level — The negative pressure that the patient has to create to trigger the ventilator to deliver a breath.

PRVC—Pressure-regulated volume control

PS—Pressure support

PS above P_{high}—Inspiratory pressure support level for breaths triggered during the Thigh period in Bi-Vent (cmH₂O)

PS above PEEP—Inspiratory pressure support level for breaths triggered during the TPEEP period in Bi-Vent (cmH₂O)

Re—expiratory resistance

RH—Relative humidity

Respiratory Rate—Rate of controlled mandatory breaths or used for calculating target volume (b/min)

Ri—inspiratory resistance

RR—Respiratory rate

Service card—Field service software card

SIMV—Synchronized Intermittent Mandatory Ventilation

SIMV rate—Rate of controlled mandatory breaths (b/min)

Start breath—Manually triggered set breath

STPD - Standard Temperature and Pressure Dry. All measured, inlet gas pressures and flows at +20 °C (standard temperature), standard pressure 101.3 kPa and relative humidity 0 % (dry).

T—Time

Tc—Time constant

Ti—Inspiration time

Ti/T_{tot}—Duty cycle or ratio of inspiration time to total breathing cycle time (only during spontaneous breathing)

Tidal Volume—Volume per breath or target volume (ml)

Thigh—Time at P_{high} level in Bi-Vent (s)

TPEEP—Time at PEEP level in Bi-Vent (s)

\dot{V} —Flow

\dot{V}_{ee} —End expiratory flow

\dot{V}_{leak} —Leakage flow (l/min)

VC—Volume Control

V_{Te}—Expiratory Tidal Volume

V_{Ti}—Inspiratory Tidal Volume

13 APPENDIX • USER INTERFACE

TABLE OF CONTENTS

13.1	Fixed keys	166
13.2	Special function keys	167
13.3	Quick access key	168
13.4	Main screen key	169
13.5	Menu Key	170
13.6	Biomed menu (standby mode)	172
13.7	Screen touchpads	174

13.1 FIXED KEYS

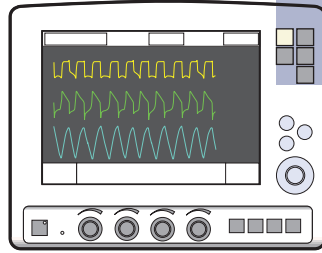

	Audio pause (Silence or pre-silence alarms)	
Alarm profile	Alarm profile setup. Possible selections: <ul style="list-style-type: none"> ■ Pressure (upper) ■ Minute volume (lower and upper) ■ Respiratory rate (lower and upper) ■ End expiratory pressure (lower and upper) ■ Alarm sound level (10-100%) 	By pressing <i>Autoset</i> in controlled modes of ventilation the alarm limits are automatically set for: <ul style="list-style-type: none"> ■ Pressure ■ Volume ■ Resp. Rate ■ PEEP In spontaneous modes an alarm setting for apnea time is available.
	<p>Note: In NIV the alarm sound can be permanently silenced (audio off).</p>	<p>Note: Autoset is not possible in NIV.</p>
Trends	The trend graph appears when the <i>Trend</i> key is pressed. Data can be recorded over a period of time up to 24 hours. The time resolution is displayed in the trend graph.	

13.2 SPECIAL FUNCTION KEYS

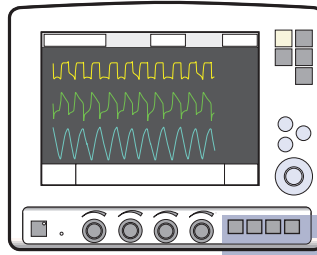

Start breaths	The ventilator will initiate a new breath cycle according to the current ventilator settings.
O₂ breaths	<p>This function allows 100% oxygen to be given for 1 minute. After this time the oxygen concentration will return to the pre-set value. The oxygen breaths can be interrupted by pressing the <i>O₂ breaths</i> fixed key during the 1 minute interval.</p> <p>Note: If <i>O₂ breaths</i> is activated during the pre- or post-oxygenation phase in Suction Support the procedure will be discontinued.</p>
Exp. hold	Expiratory hold is activated by manually pressing the <i>Exp. hold</i> key. The maximum time is 30 seconds. The inspiratory and expiratory valves close after expiration. This function can provide an exact measurement of the end expiratory lung pressure. It can be used for static compliance measurement and to determine the total PEEP.
Insp. hold	Inspiratory hold is activated by pressing the <i>Insp. hold</i> key. The maximum time is 30 seconds. The inspiratory and expiratory valves close after expiration. This function can provide an exact measurement of the end inspiratory lung pressure. It can be used during x-ray or to determine Plateau pressure, or static compliance calculation.

13.3 QUICK ACCESS KEY

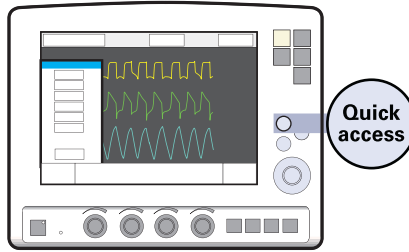

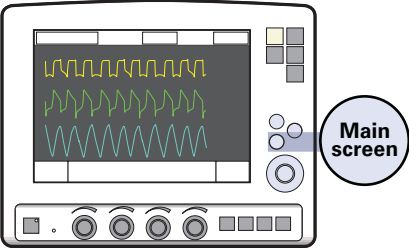

<p>Suction Support</p>	<p>This function allows the user to disconnect the patient from the ventilator and turns off the alarms (for apnea, minute volume, frequency alarm, check tubing, low PEEP) during suction support.</p> <p>Note: Suction support is not available when NIV or O₂ breaths are activated.</p>
<p>Loops</p>	<p>Loops are graphs that show two measured values: one measured value (x-axis) against another measured value (y-axis). Loops are updated breath by breath.</p> <p>Two loops are available:</p> <ul style="list-style-type: none"> ■ volume-pressure ■ flow-volume
<p>Waveform scales</p>	<p>Waveform scaling</p> <ul style="list-style-type: none"> ■ Pressure scaling ■ Flow scale ■ Volume scale <p>These three scales are set to automatic scaling, by default.</p> <p>The sweep speed (mm/s) can be set to 10 or 20 mm/s (default).</p>
<p>Waveform configuration</p>	<p>Possibility to increase the space for viewing the waveform curves. This means that more detailed information can be viewed.</p>

13.4 MAIN SCREEN KEY

	<p>Main screen</p> <p>The <i>Main screen</i> fixed key will return you to the Main screen, cancelling current work, from wherever you are in the Menu/dialog windows.</p>
---	--

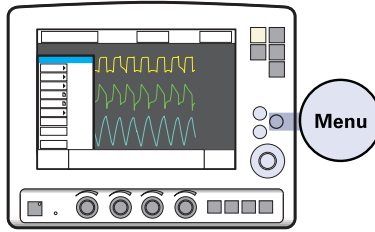
13.5 MENU KEY



Alarm	Alarm profile setup	
<i>Alarm:Profile</i>	<p>Alarm profile setup. Possible selections:</p> <ul style="list-style-type: none"> ■ Pressure (upper) ■ Minute volume (lower and upper) ■ Respiratory rate (lower and upper) ■ End expiratory pressure (lower and upper) ■ Alarm sound level (10-100%) <p>Note: In NIV the alarm sound can be permanently silenced (audio off).</p>	<p>By pressing <i>Autoset</i> in controlled modes of ventilation the alarm limits are automatically set for:</p> <ul style="list-style-type: none"> ■ Pressure ■ Volume ■ Resp. Rate ■ PEEP <p>In spontaneous modes an alarm setting for apnea time is available.</p> <p>Note: Autoset is not possible in NIV.</p>
<i>Alarm:History</i>	This shows alarms that have been activated. The list is in alphabetical order.	
<i>Alarm:</i> 	Audio pause (Silence or pre-silence alarms)	
Review		
<i>Review:Trends</i> <i>Review:Event log</i> <i>Review:View configuration</i>	Review trends, event log or configuration.	

Compensate	
<i>Compensate:Compliance</i>	Under " <i>Compliance</i> " it is possible to activate or deactivate circuit compliance compensation.
Biomed	
<i>Biomed:O₂ cell adaptation</i> (only during ventilation)	Measured O ₂ concentration will be adapted in relation to set value.
Panel lock	Locks all user input functions on the User Interface. Press <i>Main screen</i> fixed key to unlock.

13.6 BIOMED MENU (STANDBY MODE)

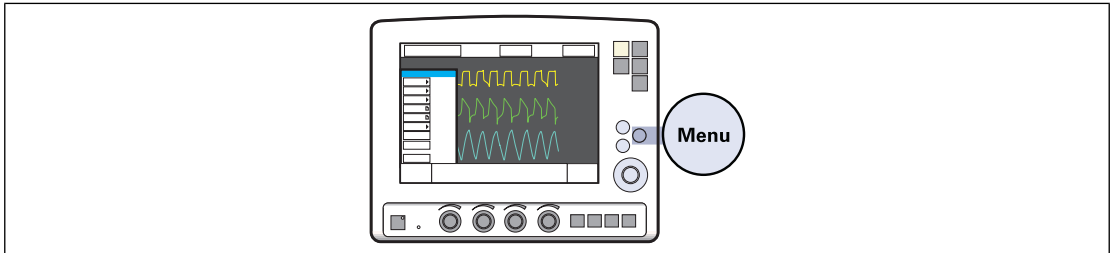

Biomed		
	Enter code 1973 to access Biomed menus. The access code can be changed by the user.	
Service:Event log <i>Alarms</i> <i>Ventilator settings</i> <i>Functions</i>	Display Event logs. Possible selections: ■ latest logs ■ selected time interval	
Service:Service log <i>Technical alarms</i> <i>Test results</i> <i>Preventive maintenance</i> <i>Service report history</i> <i>Installation log</i>	Display service logs. Possible selections: ■ 21 latest logs ■ selected time interval	
Service:Report PM	Enters a date for the preventative maintenance into the service log.	
Service:Replaced Exp membrane	Reset of breath counter in expiratory cassette.	

Edit configuration <i>Alarm sound level</i> <i>Alarm limits</i> <i>Displayed values</i> <i>NIV alarms</i> <i>Startup configuration</i>	User default configuration setup.
Copy configuration	Copy configuration to/from PC card.
Set date and clock	Date and time setup.
Change access code	Change access code to Biomed menu.
Start MCare Remote Service	Starts MCare Remote Service function

13.7 SCREEN TOUCHPADS

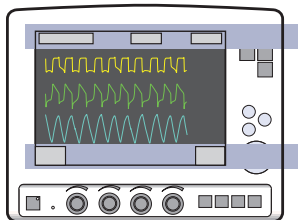

<p>Mode Xxxxx</p>	<p>When the touchpad for a selected ventilation mode is pressed, a window appears with the valid settings for this mode. The window has an <i>Accept</i> touchpad and a <i>Cancel</i> touchpad. When the <i>Accept</i> touchpad is pressed the ventilator starts to ventilate with the new settings. If the <i>Cancel</i> touchpad is pressed this window will disappear and the ventilator will continue to ventilate with the original settings. To support the clinician in adjusting settings some values, derived from settings, are shown in the upper right field of the set ventilation mode window e.g. inspiration time in seconds, calculated inspiratory flow.</p>
<p>Admit patient</p>	<p>When the admit patient function is activated the clinician can enter or amend patient details:</p> <ul style="list-style-type: none"> ■ patient name ■ identity number ■ date of birth ■ date of admission ■ height ■ weight
<p>Status</p> <p><i>General</i></p> <p><i>O₂ cell/sensor</i></p> <p><i>Exp. cassette</i></p> <p><i>Batteries</i></p> <p><i>Installed options</i></p> <p><i>Pre-use check</i></p>	<p>In the Status function, an icon displays which power source is currently active i.e. Mains, Ext. 12 V, or battery. When the batteries are in use, information about remaining time is also displayed. When the <i>Status</i> touchpad is activated a windows appears displaying the status of:</p> <ul style="list-style-type: none"> ■ General system information ■ Status of O₂ cell/sensor ■ Status of Expiratory cassette ■ Status of batteries ■ Installed options ■ Status of Pre-use check

Additional settings	
<i>I:E/Insp. times</i>	<p>Press the <i>Additional settings</i> touchpad to see the settings available for the current mode.</p> <p>Vital parameters are set using the Direct Access Knobs.</p> <p>The bar below the numeric value is a graphical representation of the chosen value and gives information about the parameter ranges.</p> <ul style="list-style-type: none"> ■ the bar is white if your setting is within what is generally considered safe ranges ■ the bar turns yellow if your setting is slightly beyond what is generally considered safe ranges ■ the bar turns red if your setting is significantly beyond what is generally considered safe ranges
<i>Trigger</i>	<p>The trigger sensitivity bar is colored based on the setting:</p> <ul style="list-style-type: none"> ■ the bar is green for a normal setting for flow triggering ■ the bar is red when there is a risk of self-triggering ■ the bar is white when pressure triggering is selected. <p>Note: If there is leakage in the breathing system, e.g. if an uncuffed endotracheal tube is used, triggering will then be initiated by the system and not by the patient. This should always be avoided by decreasing the trigger sensitivity.</p>
<i>Backup ventilation</i>	This touchpad will be visible in supported ventilation modes.
Additional values	<p>This is an area of the screen which shows which shows measured/calculated numerical values.</p> <p>Three pages with values are available. By pressing Additional values it is possible to scroll between the pages.</p> <p>Note: In NIV, only one page is available.</p>

14 CERTIFICATES

TABLE OF CONTENTS

14.1	China	178
------	-------	-----

14.1 CHINA

CFDA registration no	CFDA(I)20133544789
Product standard no	YZB/SWE 6113-2013
Manufacturing date	For manufacturing date, see label on the device
Manufacturer	Maquet Critical Care AB
Manufacturer/Manufacturer site address	Rontgenvagen 2, SE-17154 Solna, Sweden
Agent for registration and after sales	Maquet (Shanghai) Medical Equipment Co., Ltd.
Agent address	Room 227, 2nd floor, No. 56, Meisheng Road, Pilot Free Trade Zone, Shanghai, China
Agent contacts	800 820 0207
IFU revise date	150810

15 INDEX

- A**
- Activity instruction 37
 - Additional values 60
 - Aeroneb Professional Nebulizer System 129
 - Alarm output connection 121, 156
 - Alarm profile 126
 - see Set alarm limits
 - Alarms
 - Alarm (technical data) 153
 - Alarm profile 53
 - Autoset 53, 53, 53, 154
 - High priority alarms 123, 125, 133
 - Low priority alarms 123, 125, 138
 - Medium priority alarms 123, 123, 125, 136
 - Permanently silencing 125
 - Silence/Pre-silence 124
 - Alarm settings 153
 - Appendix
 - Fixed keys 166
 - Main screen key 169
 - Menu key 170
 - Quick access key 168
 - Screen touch pads 174
 - Special function keys 167
- B**
- Backup ventilation 110
 - Battery status 36
 - Battery status window 36, 38
 - Biomed 26, 140, 172
 - Bi-Vent 103
 - BTPS 147, 163
- C**
- Charging/Operating time 37
 - Communication/Interface 156
 - Compressor Mini 157
 - Copy configuration 140
- D**
- Definitions 163
 - Device description 6
 - Device description
 - Compressor Mini 157
 - Mobile cart 157
 - Dimensions 146
 - Direct access knob 24
- E**
- EMC 144
 - Event log 64, 122, 156
 - Expiratory cassette 32
 - Expiratory channel 149
 - Expiratory hold 116, 117
 - External 12 V 27, 36, 145
- F**
- Factory set default 151, 152
 - Fisher & Paykel
 - Humidifier 128
 - Fixed keys 18, 23, 116, 166
 - Flow trigger level 163
- G**
- Gas flow 31, 32
 - Gas supply 146
- H**
- Helmet 130
 - High priority alarms 123, 125, 133
 - Humidifier
 - Fischer & Paykel 128
 - Teleflex Medical 128
- I**
- I:E ratio 68, 74
 - I:E ratio/inspiration time 74
 - Informative text message 38
 - Inspiratory channel 32, 148

- Inspiratory hold 116, 117
- Inspiratory rise time 73, 113
- Intended use 6
- Intended user 6
- Internal tests 44
- Invasive ventilation 54

L

- Loops 64, 168
- Low priority alarms 123, 125, 138

M

- Main rotary dial 19, 22
- Main screen key 169
- Mandatory breath 94, 95
- Measured values 60
- Medium priority alarms 123, 123, 125, 136
- Menu key 26
- Minute volume 68
- Mobile cart 34, 34, 34, 157
- Monitoring
 - Technical data 149

N

- Nasal mask 106
- NIV 54, 106, 106
- Non Invasive Ventilation 54, 106, 106
- Non-operating conditions 144

O

- O2 breaths 116, 116
- O2 cell 32, 32, 32, 58
- O2 sensor 32
- Operating conditions 144
- Options 51

P

- Patient breathing system 32
- Patient circuit test 50
- Patient data 50
- Patient range 144
- Patient unit
 - Connections and labels 28, 29

- Gas flow 32
- Pause time (T pause) 113
- PEEP 74, 113
- Power supply 35, 157
- Pressure Control 71, 83, 83
- Pressure Regulated Volume Control (PRVC)
 - 86, 87
- Pressure Support 89
- Pre-use check 42
- Previous mode 77
- PRVC 86, 87

Q

- Quick access key
 - Loops 168
 - Scales 168

R

- Respiratory rate 76, 76
- Review 170

S

- Service 7, 157
- Service Log 156
- Servo Duo Guard 157
- Servo Guard 157
- Set alarm limits 53
- Setting range 151, 152
- Shelf base 157
- SIMV 94
- SIMV Pressure Control + Pressure Support 94, 99
- Spontaneous breathing/CPAP 69, 92, 93
- Standards 12, 144
- Standby 19, 19, 108, 170, 172
- Start breath 116, 116, 156
- Start-up configuration 139
- Status 27
- STPD 147, 164
- Suction support 56
- Support arm 10, 34
- Symbols

Patient unit 30
User interface 18, 20

T

Technical error messages 138
The system
 Technical data 143
Tidal volume 113
Touch screen 21
Trends 65
Trigger
 Functionality 72
 Indication 20, 20
 Trigger sensitivity 113, 113
Troubleshooting
 High priority alarms 125, 133
 Low priority alarms 138
 Medium priority alarms 125, 136
 Pre-use check messages 47
 Technical errors 138
Type of ventilation 51

U

User interface
 Appendix 165
 Basic principles 16, 18, 21

V

Ventilation
 Bi-Vent 103, 105
 I:E ratio/inspiration time 74
 Mandatory breath 95
 Modes of ventilation 70
 Parameters 113
 Pressure Control 71, 83
 Pressure Support 89
 PRVC 86
 Settings 55, 72, 126, 151
 Set ventilation mode 52, 52
 SIMV 94
 Spontaneous breathing/CPAP 69, 92, 93
 Supported ventilation 89

Type of ventilation 51
 Volume Control 70, 78
Ventilator 16, 146
Ventilatory 69, 113
Volume Control 70, 78
Volume Control with alternative flow patterns 81

W

Warnings 8
Water trap 128
Waveform 62
Weight 13, 42, 51, 144
Workflow 42

MAQUET

GETINGE GROUP

Maquet Critical Care AB
Röntgenvägen 2
SE-171 54 Solna, Sweden
Phone: +46 (0) 8 730 73 00
www.maquet.com

For local contact:
Please visit our website
www.maquet.com



0123

GETINGE GROUP is a leading global provider of products and systems that contribute to quality enhancement and cost efficiency within healthcare and life sciences. We operate under the three brands of ArjoHuntleigh, GETINGE and MAQUET. ArjoHuntleigh focuses on patient mobility and wound management solutions. GETINGE provides solutions for infection control within healthcare and contamination prevention within life sciences. MAQUET specializes in solutions, therapies and products for surgical interventions, interventional cardiology and intensive care.

SERVO-s VENTILATOR SYSTEM V7.0

User's Manual